

# capri

design bolzan LAB



Una semplicità che nasce da una profonda ricerca e cultura dell'arredo, per un letto che arricchisce lo spazio notte di una presenza rassicurante e raffinata. La testata imbottita, dalle linee armoniose, è proposta sia in versione liscia che con lavorazione capitonnè, mentre il giroletto può essere con piedini a vista o arricchito con un sartoriale ed elegante gonnellina.

A simplicity coming from a deep research and culture of furniture, for a bed that enriches the bedroom with a reassuring and refined presence. The padded headboard, with its harmonious lines, is available in both smooth and capitonné version, while the bedframe can be with visible feet or enriched with a tailored and elegant skirt.

## informazioni tecniche / technical info:

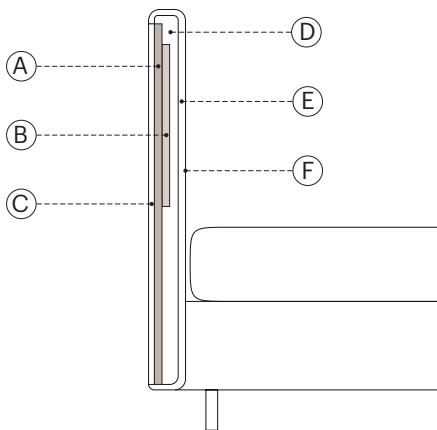

### testata / headboard

- A. truciolare 20mm / 20mm chipboard
- B. multistrato pioppo 10 mm / 10 mm poplar plywood
- C. espanso ignifugo D 25 kg/mc / fire resistant foam D 25 kg/mc
- D. espanso ignifugo D 50 kg/mc / fire resistant foam D 50 kg/mc
- E. resinato poliestere ignifugo 100g / 100g fire resistant resin polyester fibre
- F. maglina polipropilene 70g / 70g polypropylene mesh

### h 20

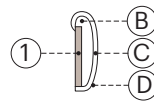

### h 29

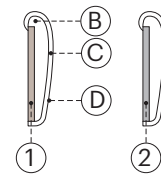

### giroletti / bedframes

- 1. listellare abete 22mm 3 strati / 22mm 3-layer fir blockboard
- 2. estruso in alluminio 22mm / 22 mm extruded aluminum
- B. espanso ignifugo D 35 kg/mc / fire resistant foam D 35 kg/mc
- C. resinato poliestere ignifugo 100g / 100g fire resistant resined polyester fiber
- D. maglia polipropilene 70g / 70g polypropylene mesh

## predisposto per materassi / for mattresses:

120	x	200	47 <sup>2</sup> / <sub>8</sub> "	x	78 <sup>6</sup> / <sub>8</sub> "
160	x	200	63"	x	78 <sup>6</sup> / <sub>8</sub> "
170	x	200	66 <sup>7</sup> / <sub>8</sub> "	x	78 <sup>6</sup> / <sub>8</sub> "
180	x	200	70 <sup>7</sup> / <sub>8</sub> "	x	78 <sup>6</sup> / <sub>8</sub> "

153	x	203	60"	x	80"	<b>Queen size</b>
193	x	203	76"	x	80"	<b>King size</b>

## personalizzazioni disponibili / available customizations:



plane

capitonné

gonnellina / skirt

gonnellina / skirt  
chic

# Capri Plane / Firwood structure

Standard feet Vasetto - completely removable cover in fabric - non removable headboard cover in leather or eco-leather

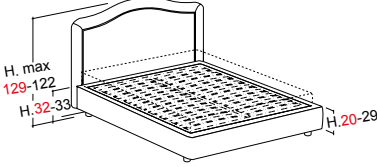
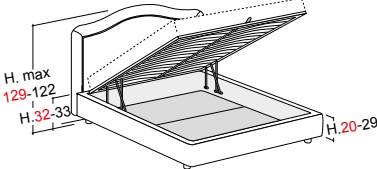
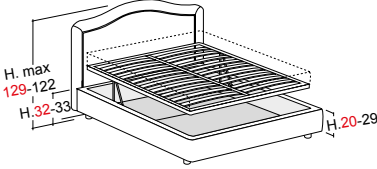
	Mattress	Ext. dimension	Code	D	C	A	Plus	Luxury fabric	Luxury leather	Nuvola fabric	Nuvola leather	TCL	Cover			
													ml	mc	kg	
<b>rounded base h.20 - rounded base h.29</b> without slatted base (to choose a slatted base see flap on the right)																
 <p>H. max 129-122 H. 32-33 H. 20-29</p>	120x200	138x216	<b>MRD29</b>										7.5	0.36	56	
	150x200	168x216	<b>MRI29</b>										8.3	0.4	61	
	153x203 QUEEN 60x80"	171x219	<b>MRQ29</b>										8.3	0.4	61	
	160x200	178x216	<b>MRM29</b>										8.5	0.41	63	
	170x200	188x216	<b>MRF29</b>										9	0.42	68	
	180x200	198x216	<b>MRG29</b>										9.5	0.44	72	
	190x200	208x216	<b>MRP29</b>										10.5	0.47	78	
	193x203 KING 76x80"	211x219	<b>MRK29</b>										10.5	0.47	78	
	Loose cover			<b>RMR</b>										0.02		8
<b>rounded base h.20 - rounded base h.29 w/BOX</b> orthopaedic slatted base included suggested weights for mattresses (see flap on the right)																
 <p>H. max 129-122 H. 32-33 H. 20-29</p>	120x200	138x216	<b>MRD29B</b>										7.5	0.55	115	
	150x200	168x216	<b>MRI29B</b>										8.3	0.65	126	
	153x203 QUEEN 60x80"	171x219	<b>MRQ29B</b>										8.3	0.65	126	
	160x200	178x216	<b>MRM29B</b>										8.5	0.67	128	
	170x200	188x216	<b>MRF29B</b>										9	0.7	136	
	180x200	198x216	<b>MRG29B</b>										9.5	0.72	142	
	190x200	208x216	<b>MRP29B</b>										10.5	0.75	150	
	193x203 KING 76x80"	211x219	<b>MRK29B</b>										10.5	0.75	150	
	Loose cover			<b>RMR</b>										0.02		8
<b>rounded base h.20 - rounded base h.29 w/easy-up BOX</b> orthopaedic slatted base included suggested weights for mattresses (see flap on the right)																
 <p>H. max 129-122 H. 32-33 H. 20-29</p>	120x200	138x216	<b>MRD29BE</b>										7.5	0.59	125	
	150x200	168x216	<b>MRI29BE</b>										8.3	0.69	136	
	153x203 QUEEN 60x80"	171x219	<b>MRQ29BE</b>										8.3	0.69	136	
	160x200	178x216	<b>MRM29BE</b>										8.5	0.71	138	
	170x200	188x216	<b>MRF29BE</b>										9	0.74	146	
	180x200	198x216	<b>MRG29BE</b>										9.5	0.76	152	
	190x200	208x216	<b>MRP29BE</b>										10.5	0.79	160	
	193x203 KING 76x80"	211x219	<b>MRK29BE</b>										10.5	0.79	160	
	Loose cover			<b>RMR</b>										0.02		8

Available on request bedbases for mattresses of 190 cm (surcharge 5%) or 210 cm (15% surcharge) length.  
 For other bespoke requests 30% surcharge.

# Capri plane / Aluminum structure

Standard feet Vasetto - completely removable cover in fabric - non removable headboard cover in leather or ecoleather

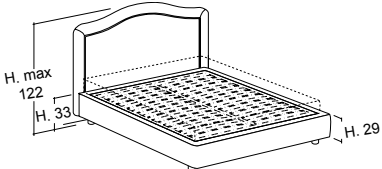
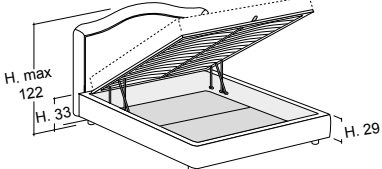
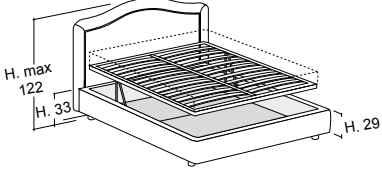
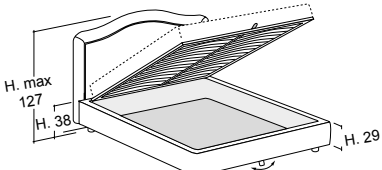
	Mattress	Ext. dimension	Code	D	C	A	Plus	Luxury fabric	Luxury leather	Nuvola fabric	Nuvola leather	TCL	Cover		
													ml	mc	kg
<b>rounded base h.29</b>															
without slatted base (to choose a slatted base see flap on the right)															
	120x200	138x216	MRD29A										7.5	0.36	57
	150x200	168x216	MRQ29A										8.3	0.4	64
	153x203 QUEEN 60x80"	171x219	MRQ29A										8.3	0.4	64
	160x200	178x216	MRM29A										8.5	0.41	66
	170x200	188x216	MRF29A										9	0.42	71
	180x200	198x216	MRG29A										9.5	0.44	76
	190x200	208x216	MRK29A										10.5	0.47	83
	193x203 KING 76x80"	211x219	MRK29A										10.5	0.47	83
	Loose cover		RMRA										8.5	0.02	8
<b>rounded base h.29 w/BOX</b>															
orthopaedic slatted base included suggested weights for mattresses (see flap on the right)															
	120x200	138x216	MRD29BA										7.5	0.55	116
	150x200	168x216	MRQ29BA										8.3	0.65	129
	153x203 QUEEN 60x80"	171x219	MRQ29BA										8.3	0.65	129
	160x200	178x216	MRM29BA										8.5	0.67	131
	170x200	188x216	MRF29BA										9	0.7	139
	180x200	198x216	MRG29BA										9.5	0.72	146
	190x200	208x216	MRK29BA										10.5	0.75	155
	193x203 KING 76x80"	211x219	MRK29BA										10.5	0.75	155
	Loose cover		RMRA										8.5	0.02	8
available inside height in Box 18cm															
<b>rounded base h.29 w/easy-up BOX</b>															
orthopaedic slatted base included suggested weights for mattresses (see flap on the right)															
	120x200	138x216	MRD29BEA										7.5	0.59	126
	150x200	168x216	MRQ29BEA										8.3	0.69	139
	153x203 QUEEN 60x80"	171x219	MRQ29BEA										8.3	0.69	139
	160x200	178x216	MRM29BEA										8.5	0.71	141
	170x200	188x216	MRF29BEA										9	0.74	149
	180x200	198x216	MRG29BEA										9.5	0.76	156
	190x200	208x216	MRK29BEA										10.5	0.79	165
	193x203 KING 76x80"	211x219	MRK29BEA										10.5	0.79	165
	Loose cover		RMRA										8.5	0.02	8
available inside height in Box 18cm															
<b>rounded base h.29 w/HANDS FREE BOX</b>															
orthopaedic slatted base included Specify mattress weight (see flap on the right)															
	150x200	168x219	MRL29BHF										8.3	0.69	135
	153x203 QUEEN 60x80"	171x222	MRQ29BHF										8.3	0.69	135
	160x200	178x219	MRM29BHF										8.5	0.71	137
	170x200	188x219	MRF29BHF										9	0.74	145
	180x200	198x219	MRG29BHF										9.5	0.76	153
	190x200	208x219	MRP29BHF										10.5	0.79	163
	193x203 KING 76x80"	211x222	MRK29BHF										10.5	0.79	163
	Loose cover		RMRHF										8.5	0.02	8
available inside height in Box 18cm															

# Capri Capitonè / Firwood structure

Standard feet Vasetto - non removable headboard cover

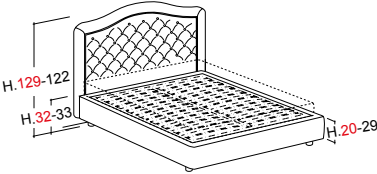
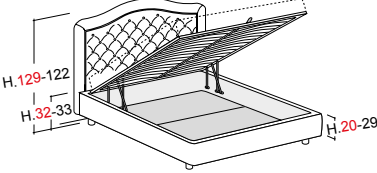
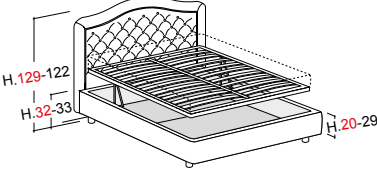
	Mattress	Ext. dimension	Code	D	C	A	Plus	Luxury fabric	Luxury leather	Nuvola fabric	Nuvola leather	TCL	Cover			
													ml	mc	kg	
<b>rounded base h.20 - rounded base h.29</b> without slatted base (to choose a slatted base see flap on the right)																
	120x200	138x216	<b>CAD29</b>										8	0.36	60	
	150x200	168x216	<b>CAL29</b>										8.3	0.39	64	
	153x203 QUEEN 60x80"	171x219	<b>CAQ29</b>										8.3	0.39	64	
	160x200	178x216	<b>CAM29</b>										8.5	0.41	67	
	170x200	188x216	<b>CAF29</b>										9	0.42	72	
	180x200	198x216	<b>CAG29</b>										9.5	0.44	77	
	190x200	208x216	<b>CAP29</b>										10.5	0.47	84	
	193x203 KING 76x80"	211x219	<b>CAK29</b>										10.5	0.47	84	
	Loose cover		<b>R29</b>											0.02	5	
<b>rounded base h.20 - rounded base h.29 w/BOX</b> orthopaedic slatted base included suggested weights for mattresses (see flap on the right)																
	120x200	138x216	<b>CAD29B</b>										8	0.55	119	
	150x200	168x216	<b>CAL29B</b>										8.3	0.63	128	
	153x203 QUEEN 60x80"	171x219	<b>CAQ29B</b>										8.3	0.63	128	
	160x200	178x216	<b>CAM29B</b>										8.5	0.67	132	
	170x200	188x216	<b>CAF29B</b>										9	0.7	140	
	180x200	198x216	<b>CAG29B</b>										9.5	0.73	147	
	190x200	208x216	<b>CAP29B</b>										10.5	0.77	156	
	193x203 KING 76x80"	211x219	<b>CAK29B</b>										10.5	0.77	156	
	Loose cover		<b>R29B</b>										3.5	0.02	5	
available inside height in Box 12-18cm																
<b>rounded base h.20 - rounded base h.29 w/easy-up BOX</b> orthopaedic slatted base included suggested weights for mattresses (see flap on the right)																
	120x200	138x216	<b>CAD29BE</b>										8	0.59	129	
	150x200	168x216	<b>CAL29BE</b>										8.3	0.67	138	
	153x203 QUEEN 60x80"	171x219	<b>CAQ29BE</b>										8.3	0.67	138	
	160x200	178x216	<b>CAM29BE</b>										8.5	0.71	142	
	170x200	188x216	<b>CAF29BE</b>										9	0.74	150	
	180x200	198x216	<b>CAG29BE</b>										9.5	0.77	157	
	190x200	208x216	<b>CAP29BE</b>										10.5	0.81	166	
	193x203 KING 76x80"	211x219	<b>CAK29BE</b>										10.5	0.81	166	
	Loose cover		<b>R29BE</b>										3.5	0.02	5	
available inside height in Box 12-18cm																

# Capri Capitoné / Aluminum structure

Standard feet Vasetto - non removable headboard cover

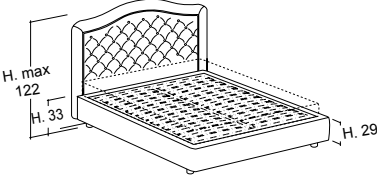
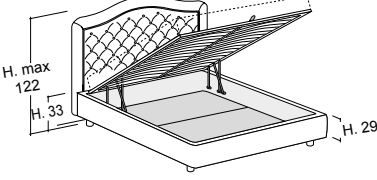
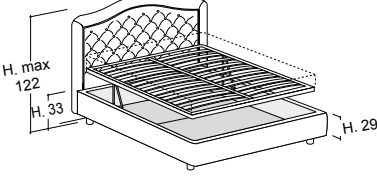
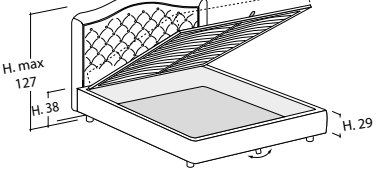
	Mattress	Ext. dimension	Code	D	C	A	Plus	Luxury fabric	Luxury leather	Nuvola fabric	Nuvola leather	TCL	Cover			
													ml	mc	kg	
<b>rounded base h.29</b>																
without slatted base (to choose a slatted base see flap on the right)																
	120x200	138x216	<b>CAD29A</b>										8	0.36	61	
	150x200	168x216	<b>CAL29A</b>										8.3	0.39	67	
	153x203 QUEEN 60X80"	171x219	<b>CAQ29A</b>										8.3	0.39	67	
	160x200	178x216	<b>CAM29A</b>										8.5	0.41	70	
	170x200	188x216	<b>CAF29A</b>										9	0.42	75	
	180x200	198x216	<b>CAG29A</b>										9.5	0.44	81	
	190x200	208x216	<b>CAP29A</b>										10.5	0.47	89	
	193x203 KING 76X80"	211x219	<b>CAK29A</b>										10.5	0.47	89	
	Loose cover			<b>R29A</b>											0.02	5
<b>rounded base h.29 w/BOX</b>																
orthopaedic slatted base included suggested weights for mattresses (see flap on the right)																
	120x200	138x216	<b>CAD29BA</b>										8	0.55	120	
	150x200	168x216	<b>CAL29BA</b>										8.3	0.63	131	
	153x203 QUEEN 60X80"	171x219	<b>CAQ29BA</b>										8.3	0.63	131	
	160x200	178x216	<b>CAM29BA</b>										8.5	0.67	135	
	170x200	188x216	<b>CAF29BA</b>										9	0.7	143	
	180x200	198x216	<b>CAG29BA</b>										9.5	0.73	151	
	190x200	208x216	<b>CAP29BA</b>										10.5	0.77	161	
	193x203 KING 76X80"	211x219	<b>CAK29BA</b>										10.5	0.77	161	
	Loose cover			<b>R29BA</b>										3.5	0.02	5
<b>rounded base h.29 w/easy-up BOX</b>																
orthopaedic slatted base included suggested weights for mattresses (see flap on the right)																
	120x200	138x216	<b>CAD29BEA</b>										8	0.59	130	
	150x200	168x216	<b>CAL29BEA</b>										8.3	0.67	141	
	153x203 QUEEN 60X80"	171x219	<b>CAQ29BEA</b>										8.3	0.67	141	
	160x200	178x216	<b>CAM29BEA</b>										8.5	0.71	145	
	170x200	188x216	<b>CAF29BEA</b>										9	0.74	153	
	180x200	198x216	<b>CAG29BEA</b>										9.5	0.77	161	
	190x200	208x216	<b>CAP29BEA</b>										10.5	0.81	171	
	193x203 KING 76X80"	211x219	<b>CAK29BEA</b>										10.5	0.81	171	
	Loose cover			<b>R29BEA</b>										3.5	0.02	5
<b>rounded base h.29 w/HANDS FREE BOX</b>																
orthopaedic slatted base included Specify mattress weight (see flap on the right)																
	150x200	168x219	<b>CAL29BHF</b>										8.3	0.67	137	
	153x203 QUEEN 60X80"	171x222	<b>CAQ29BHF</b>										8.3	0.67	137	
	160x200	178x219	<b>CAM29BHF</b>										8.5	0.71	141	
	170x200	188x219	<b>CAF29BHF</b>										9	0.74	149	
	180x200	198x219	<b>CAG29BHF</b>										9.5	0.77	158	
	190x200	208x219	<b>CAP29BHF</b>										10.5	0.81	169	
	193x203 KING 76X80"	211x222	<b>CAK29BHF</b>										10.5	0.81	169	
Loose cover			<b>R29HF</b>										3.5	0.02	5	

Available on request bedbases for mattresses of 190 cm (surcharge 5%) or 210 cm (15% surcharge) length.  
For other bespoke requests 30% surcharge.

## GIROLETTI E PIEDINI / BEDFRAMES AND FEET

### bedframe h.9 cm



cilindro  
H 26 cm 10<sup>2</sup>/<sub>8</sub>"



vasetto  
H 26 cm 10<sup>2</sup>/<sub>8</sub>"



vasetto inclinato  
H 26 cm 10<sup>2</sup>/<sub>8</sub>"



tubino  
H 26 cm 10<sup>2</sup>/<sub>8</sub>"



lamina  
H 26 cm 10<sup>2</sup>/<sub>8</sub>"



arco  
H 26 cm 10<sup>2</sup>/<sub>8</sub>"

### bedframe h.20 cm



cilindro  
H 12,5 cm 4<sup>7</sup>/<sub>8</sub>"



vasetto  
H 12,5 cm 4<sup>7</sup>/<sub>8</sub>"



tubino  
H 12,5 cm 4<sup>7</sup>/<sub>8</sub>"



lamina  
H 15 cm 5<sup>7</sup>/<sub>8</sub>"

### bedframe h.29 cm



vasetto h. 4cm  
H 4 cm 1<sup>5</sup>/<sub>8</sub>"



vasetto h. 9-12,5 cm  
H 9 cm 3<sup>4</sup>/<sub>8</sub>"  
H 12,5 cm 4<sup>7</sup>/<sub>8</sub>"



cipolla  
H 8 cm 3<sup>1</sup>/<sub>8</sub>"

### pedini in legno / wooden feet:

pedini realizzati in legno di pincopallo con possibilità di essere tinti, verniciati ral o foderati in tessuto a scelta.

pedini realizzati in legno di pincopallo con possibilità di essere tinti, verniciati ral o foderati in tessuto a scelta.

### finiture legno tinto / lacquered wood finishes:



noce / walnut



ciliegio / cherry



rovere / oak



wengè

### pedini in metallo / metal feet:

pedini realizzati in acciaio con possibilità di essere verniciati effetto ottone o colori ral.

pedini realizzati in acciaio con possibilità di essere verniciati effetto ottone o colori ral.

### finiture metallo / metal finishes:



ottone satinato /  
brushed brass

### finiture laccati ral / ral lacquered finishes:



bianco / white  
RAL 9010



perla / pearl  
RAL 1013



nero / black  
RAL 9011



grigio / grey  
RAL 7044



marrone / brown  
RAL 8019



rosso / red  
RAL 3005



verde / green  
RAL 6020



blu / blue  
RAL 5008

## h. 20-29 SISTEMA CONTENITORE / BOX SYSTEM



box

### BOX

apertura basic del box grazie ad un semplice sistema a leva / basic opening of storage box thanks to a simple lever system

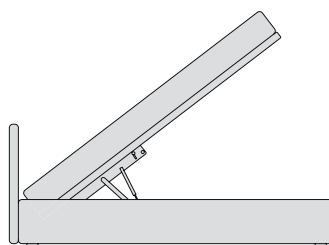

interno in legno



interno in alluminio

### HANDS-FREE

apertura del box senza l'uso delle mani e grazie al box completamente in alluminio è privo di pistoncini a vista / The mechanism allows to open the storage box without hands, and thanks to its aluminum structure, the storage box has inner pistons, thus maintaining a top-notch design

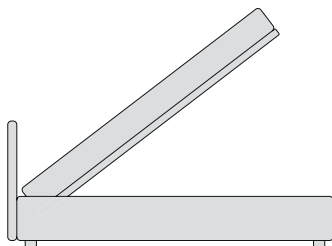

interno in alluminio

### EASY UP

grazie al movimento che mantiene la rete all'interno dello spazio occupato dal letto, ottimizza lo spazio all'interno della stanza / mechanism optimizes the space inside the room thanks to its movement that keeps the slatted base within the space occupied by the bed

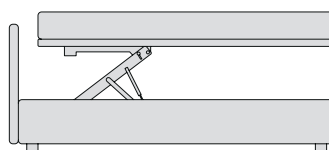

interno in legno



interno in alluminio

## h. 20-29 INCASSO MATERASSO / MATTRESS RECESS

La struttura dei letti Bolzan permette di soddisfare le diverse esigenze di progettazione: l'incasso del materasso nella struttura del letto è personalizzabile in 7 altezze diverse. Non disponibile per le basi con box.

Bolzan beds' structure allows you to meet different design needs: the mattress recess in the bed's structure is customizable in 7 different heights. It is not available for bases with box.

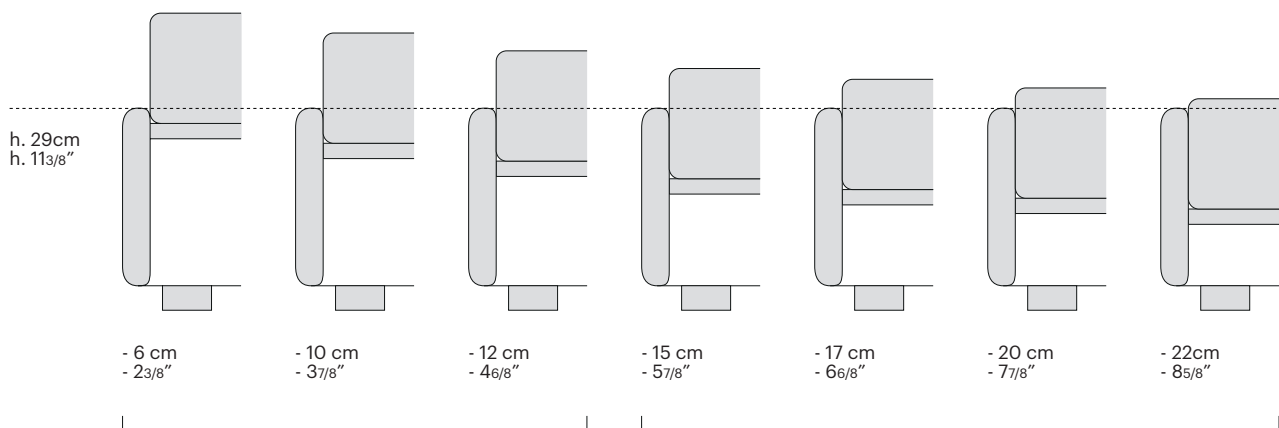

ribassamento disponibile per giroletto h. 20 e h. 29 cm /  
mattress recess available for h. 20 and h. 29 cm bedframes

ribassamento disponibile solo per giroletto h. 29 cm /  
mattress recess available for h. 29 cm bedframe

## INFORMAZIONI SUI MATERIALI

### Legno

Tutto il legname proviene da produttori certificati PEFC/CTM, ciò significa che il legno proviene da piantagioni di riforestazione, dove ogni pianta utilizzata viene sostituita da una nuova per non distruggere l'ambiente anzi aumentandone l'apporto di ossigeno all'interno dell'atmosfera.

Bolzan Letti, da sempre particolarmente attenta alla politica ambientale e al perseguimento di nuovi obiettivi di miglioramento del proprio prodotto anche e soprattutto in termini di tutela della salute delle persone, ha già scelto di andare oltre, acquistando solo pannelli compensati certificati CARB e CARB2. Destinati a tutta la produzione e non solo ai prodotti da immettere sul mercato Usa.

### Alluminio 100% riciclabile

Resistente, leggero e durevole, l'alluminio non si altera nel tempo e può essere fuso e riciclato all'infinito, con un ridotto consumo di energia, senza perdere le sue caratteristiche originali. Ecco perché si può definire un materiale eco-sostenibile per eccellenza, a vantaggio della qualità della vita di oggi e di domani.

### Gommapiuma e rivestimento interno

Dal sapiente taglio dei blocchi di gomma nascono tutte le imbottiture. Nelle imbottiture è fondamentale saper scegliere le varie densità di gomma in quanto ogni parte del letto risponde ad esigenze estetiche-funzionali diverse. L'uso di poliuretano espanso ad alta densità ed indeformabile garantisce comfort e durata. Tutti gli imbottiti vengono foderati con dacron accoppiato a velfodera resistente alla luce ed ignifuga, secondo le normative standard mondiali.

### Materiali riciclati/riciclabili

È stata posta attenzione anche alle imbottiture, realizzate prevalentemente in schiumati riciclabili. Il poliuretano espanso flessibile, comunemente noto come "gommapiuma", rappresenta l'imbottitura in assoluto più utilizzata, grazie alla vasta gamma disponibile per formati e densità. Le rimanenze vengono riconvertite in lastre di agglomerato espanso che vengono interamente riutilizzate all'interno della produzione annullando gli scarti di materia prima.

### Colle atossiche

La colla utilizzata è a base d'acqua per ridurre la presenza di solventi sintetici. I vantaggi dell'utilizzo della vernice all'acqua, si esprimono nella grande sostenibilità e limitato impatto ambientale nell'uso di questo prodotto. Grazie all'utilizzo delle vernici e colle all'acqua è infatti possibile ridurre del 95 per cento le emissioni nell'ambiente di composti organici volatili (COV), diversamente dall'impiego di comuni vernici a solvente. Altro vantaggio relativo all'utilizzo di colle ad acqua, è che questi prodotti sono completamente inodore, non infiammabili e caratterizzati da livelli di tossicità estremamente limitati.

### Materiali alternativi / cocco

La ricerca continua e la volontà di innovare in maniera sostenibile ha portato l'azienda a utilizzare materiali alternativi come le lastre di cocco che compongono l'imbottitura dei letti. La fibra di cocco viene raccolta dall'omonimo albero in India, Sri Lanka, Indonesia, Brasile. Le fibre di cocco vengono impregnate con lattice naturale. L'amalgama risultante (il cocco gommato) viene vulcanizzato e successivamente sagomato in lastre di varie formati, spessori e densità. È possibile inoltre avere lastre sagomate con canali trasversali atti a favorire un'ulteriore traspirabilità. Rispetto ad altri materiali, l'impiego del cocco nella lavorazione di imbottiti ha il vantaggio, di un facile e rapido confezionamento del prodotto, dato che le lastre in cocco gommato possono essere incollate, graffettate e cucite mantenendo inalterata la loro caratteristica principale che è la robustezza: non si sfaldano nel tempo, non provocano polvere, non assorbono umidità. Oltre a ciò si presta ad essere utilizzato all'interno di poltrone e materassi raggiungendo il 20% di peso in meno.

### Materiali alternativi / ovatta

L'ovatta contribuisce a garantire il benessere della persona durante il riposo, restando a contatto con il corpo insieme al tessuto e determinando una piacevole sensazione di comfort. Bolzan Letti dedica a questo materiale la stessa attenzione che rivolge alla costruzione delle strutture interne. L'ovatta di lana ha una microstruttura formata da una fitta rete di fibre che dona all'imbottitura naturali doti di traspirabilità, indeformabilità e durata nel tempo. L'ovatta di poliestere è un materiale non solo soffice, indeformabile, resistente, ipoallergenico, inattaccabile da acari e muffe e idrorepellente, ma anche ecosostenibile. È infatti composta al 75% da fibre provenienti dal riciclo di bottiglie di plastica e quindi è a sua volta facilmente riciclabile. Inoltre è certificata Oeko-Tex Classe 1 e ciò garantisce l'assenza di sostanze nocive.

### Tessuti

I tessuti sostenibili sono il risultato di processi produttivi industriali ecocompatibili, basati sulla riduzione di consumi energetici, sull'utilizzo di fonti di materie prime rinnovabili, sull'ottimizzazione della catena produttiva capace di ridurre l'impiego di prodotti chimici anche grazie a nuove soluzioni basate sulla biochimica e all'utilizzo delle biotecnologie.

- **Tessuti FSC** Numerosi tessuti della collezione Bolzan Letti sono marchiati FSC. Questi tessuti sono più rispettosi dell'ambiente rispetto alle fibre sintetiche o al cotone in quanto le fibre di cellulosa di cui sono fatti provengono da foreste gestite in maniera corretta e sostenibile.

- **Tessuti OEKO** L'Oeko-Tex Standard 100 è uno standard unico di certificazione e controllo nel settore delle materie prime tessili, dei semilavorati e dei prodotti finiti in tutte le fasi di lavorazione, che permette di identificare quei prodotti che non presentano alcun rischio per la salute del consumatore.

- **Tessuti PEFC** Il marchio PEFC significa che proviene da una foresta certificata (ovviamente, solo il materiale di origine forestale e arborea contenuto nel prodotto). Una foresta PEFC è una foresta gestita in linea con i più severi requisiti ambientali, sociali ed economici. Una foresta che ci sarà anche per le generazioni future.

### Pelle

Bolzan Letti utilizza esclusivamente pelli di alta qualità, provenienti da concerie selezionate e prodotte con trattamenti che rispettano l'ambiente. Il fascino e il prestigio naturali di questa materia prima, capace di donare emozioni uniche al tatto e alla vista, sono ulteriormente valorizzate da un controllo di qualità accurato che oltre all'utilizzo di moderne tecnologie, prevede l'intervento di occhi e mani esperte, per scartare tutte le parti non idonee alle lavorazioni e garantire un risultato finale perfetto.

### Imballo

Un'attenzione particolare è riservata al packaging sostenibile. Ridurlo all'essenziale per diminuire la quantità di rifiuti o utilizzare materiali naturali, biodegradabili e riciclabili è diventato un elemento importante per Bolzan Letti, che vede la sostenibilità come un valore aggiunto dei propri prodotti. Bolzan Letti ha abbandonato plastiche e polistirolo a favore degli imballaggi in cartone 100% riciclabile: cartone semplice e a nido d'ape. Le scatole contenitive sono inoltre realizzate da un nuovo macchinario che prepara imballi ad hoc a seconda delle dimensioni del prodotto riducendo al minimo gli sprechi. Per trasporti internazionali vengono utilizzati anche imballaggi in legno per proteggere al meglio il prodotto Bolzan.

### Wood

All wood comes from certified PEFC/CTM producers, which means that wood comes from reforestation plantations, where every used tree is replaced by a new one to avoid destroying the environment and thus increasing its oxygen supply to the atmosphere.

Thanks to its deep attention to environmental policy and the pursuit of new objectives for the improvement of its product, especially in terms of the protection of human health, Bolzan Letti has already chosen to go further, buying only CARB e CARB2 certified plywood panels, for all production and not only for products to be placed on the US market.

### 100% recyclable aluminium

Aluminium is resistant, lightweight and durable. Its features do not change over time and allow it to be recycled infinitely, with a limited energy consumption, and without risking the loss of its original characteristics. That is the reason why it can be defined the eco friendly material for excellence, and represents the beginning of a better quality of life for future generations.

### The foam rubber and the inner lining

From the clever cutting of the foam blocks all the paddings are formed. In the paddings it is essential to know how to use different foam densities as each part of the bed responds to different aesthetic-functional requirements. The use of high-density and non-deformable polyurethane foam guarantees comfort and durability. All the padded parts are lined with dacron coupled with flame retardant and light resistant velfodera (fibre-lining), according to world standard laws.

### Recycled / recyclable materials

Attention was also paid to the padding, made mainly of recyclable foams. The flexible polyurethane foam, commonly known as "foam rubber", represents the most widely used padding, thanks to its wide availability for sizes and densities. The surplus are reconverted into expanded agglomerate slabs that are entirely reused within our production, thus eliminating raw material waste.

### Non-toxic glues

We use water-based glue to reduce the presence of synthetic solvents. The advantages of using this water-based stain in its great sustainability and limited environmental impact. Thanks to the use of water-based components, it is in fact possible to reduce the emissions of volatile organic compounds (VOCs) by 95 percent, compared to the use of common solvent-based paints. Another advantage related to their use is that these products are completely odorless, non-flammable and characterized by extremely limited toxicity levels.

### Alternative materials / coconut

The continuous research and the will to innovate in a sustainable way led the company to use alternative materials such as the coconut slabs to make up the padding of the bed. Coconut fibers are impregnated with natural latex: the resulting amalgam (the rubberized coconut) is vulcanized and subsequently shaped into slabs of various sizes, thicknesses and densities. It is also possible to have shaped slabs with transverse channels to favor further breathability.

Compared to other materials, the use of coconut in the processing of upholstered furniture has the advantage of an easy and quick product packaging, since the rubberized coconut sheets can be glued, stapled and sewn while maintaining their main characteristic which is the same: robustness: they do not flake off over time, do not cause dust, do not absorb moisture. In addition, it is suitable to be used inside armchairs and mattresses, reaching 20% less weight.

### Alternative materials / wadding

The wadding helps to ensure the well-being of the person during rest, remaining in contact with the body together with the fabric and creating a pleasant sensation of comfort. Bolzan Letti pays the same attention to this material as it does to the construction of inner structures. The wool wadding has a microstructure formed by a dense network of fibers giving the padding natural qualities of breathability, non-deformability and durability. Polyester wadding is not only a soft, non-deformable, resistant, hypoallergenic material, resistant to mites and molds and water-repellent, but also eco-sustainable. In fact, it is usually made up of 75% fibers from the recycling of plastic bottles and is therefore easily recyclable.

### Fabrics

Sustainable fabrics are the result of environmentally friendly industrial production processes, based on the reduction of energy consumption, on the use of renewable raw material sources, and on the optimization of the production chain capable of reducing the use of chemical products also thanks to new solutions based on biochemistry and the use of biotechnology.

- **FSC fabrics** Numerous fabrics from the Bolzan collection are FSC branded. These fabrics are more environmentally friendly than synthetic fibers or cotton since the cellulose fibers they are made of come from forests that are managed correctly and sustainably.

- **OEKO fabrics** The Oeko-Tex Standard 100 is a globally uniform testing and certification system for textile raw materials, intermediate and end products at all stages, which allows to identify those products that do not present any risk to the health of the consumer.

- **PEFC fabrics** The PEFC mark means that the good comes from a certified forest (obviously, only the material of forest and arboreal origin contained in the product). A PEFC forest is a forest managed in line with the strictest environmental, social and economic requirements. A forest that will also be there for future generations.

### Leather

Bolzan Letti uses only high quality leathers, from selected tanneries and produced with treatments that respect the environment. The natural charm and prestige of this raw material, capable of giving unique emotions to the touch and sight, are further enhanced by an accurate quality control which, in addition to the use of modern technologies, involves the intervention of expert eyes and hands, to discard all parts not suitable for processing and guarantee a perfect final result.

### Packaging

Special attention is paid to sustainable packaging. Reducing it to the essential to decrease the amount of waste or the use of natural, biodegradable and recyclable materials has become an important element for Bolzan, which sees sustainability as an added value to its product system. Bolzan Letti has abandoned plastics and polystyrene in favor of 100% recyclable cardboard packaging. For all packaging there is the exclusive use of simple and honeycomb cardboard, instead of polymeric materials such as polystyrene. The containment boxes are also made from a new machine preparing ad hoc packaging according to the product size, thus waste is minimized. For international transport, wooden packaging is also used to better protect Bolzan products.