

S22
COLONNE
 TOWER UNITS / COLONNES / COLUMNS



01.2023 - V.2

ITA_ Praticità, funzionalità ed estetica sono gli elementi fondamentali per la composizione di una cucina. Per sfruttare al massimo gli spazi Alta propone molte soluzioni tra le quali le colonne con ante rientranti che svelano contenitori multifunzionali. Le grandi dimensioni definiscono una nuova essenzialità nel rapporto tra le linee verticali e le ampie superfici orizzontali.

ENG_ Practicality, functionality and aesthetics are the fundamental elements for the composition of a kitchen. To make the most of space, Alta offers many solutions, including tall units with recessed doors that reveal multifunctional containers. The large dimensions define a new essentiality in the relationship between the vertical lines and the large horizontal surfaces.

FRA_ La praticité, la fonctionnalité et l'esthétisme sont les éléments fondamentaux pour la composition d'une cuisine. Pour utiliser au meilleur les espaces, Alta propose de nombreuses solutions, notamment des colonnes avec des portes rentrantes qui révèlent des meubles multifonctionnels. Les grandes dimensions définissent une nouvelle essentialité dans la relation entre les lignes verticales et les grandes surfaces horizontales.

ESP_ Practicidad, funcionalidad y estética son los elementos fundamentales para la composición de una cocina. Para aprovechar al máximo el espacio, Alta ofrece muchas soluciones, entre ellas los muebles altos con puertas rentrantes que dejan ver contenedores multifuncionales. Las grandes dimensiones definen una nueva esencialidad en la relación entre las líneas verticales y las grandes superficies horizontales.

S22 COLONNE

TOWER UNITS / COLONNES / COLUMNAS

COLONNE PER MANIGLIA O GOLA

TOWER UNITS WITH HANDLE OR GRIP GROOVE / LES COLONNES AVEC POIGNÉE OU GORGE VERTICALE /
 COLUMNAS CON TIRADORES O RANURA

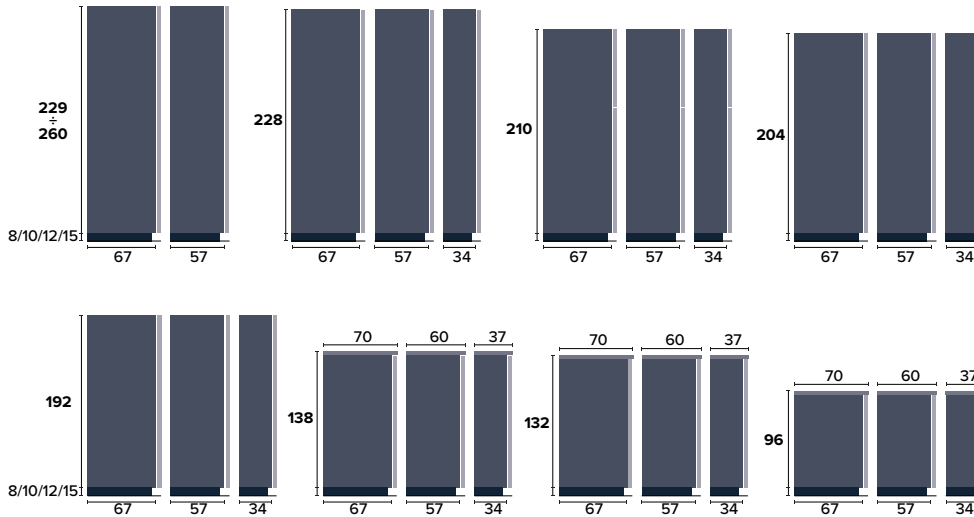

COLONNE "DOMINO"

"DOMINO" TOWER UNITS / COLONNES «DOMINO» / COLUMNAS "DOMINO"

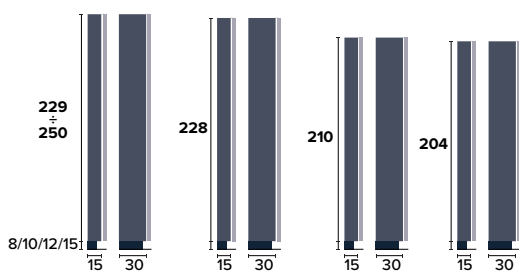

COLONNE CON ANTE RIENTRANTI

TOWER UNITS WITH POCKET DOORS / COLONNES AVEC PORTES REINTRANTES /
 COLUMNAS CON PUERTAS RENTRANTES

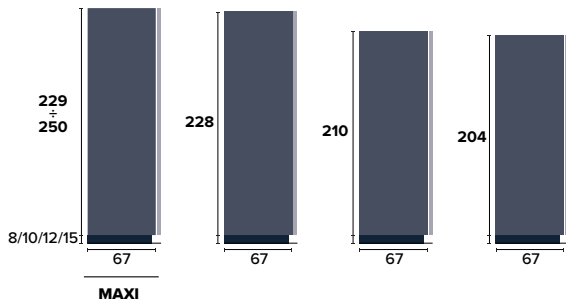

COLONNE REVEGO

REVEGO TOWER UNITS / COLONNES REVEGO / COLUMNAS REVEGO

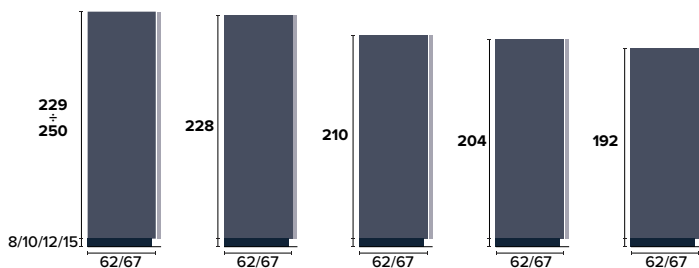

S22

COLONNE

TOWER UNITS / COLONNES / COLUMNAS

FRONTALI

FRONTS / FACADES / PUERTAS

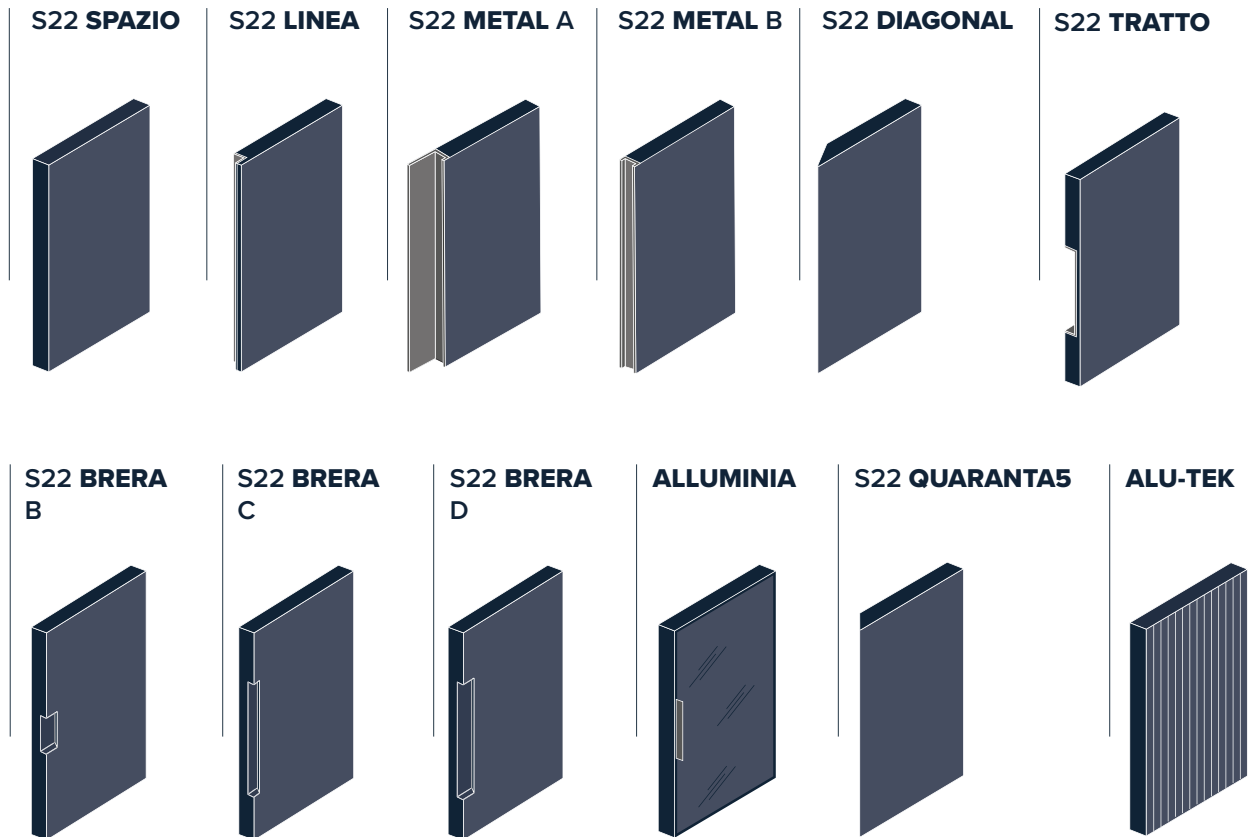

TIPOLOGIE APERTURE

OPENING METHODS /
 TYPE D'OUVERTURE /
 TIPO DE APERTURA DE LA PUERTA

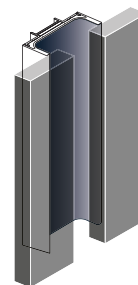
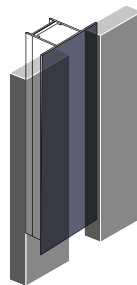

	PUSH PULL PUSH PULL PUSH PULL PUSH PULL	GOLA PIATTA FLAT GRIP GROOVE GORGE PLATE RANURA PLANA	GOLA CONCAVA CONCAVE GRIP-GROOVE GORGE CONCAVE RANURA CONCAVA	MANIGLIA HANDLE POIGNEE TIRADOR
FRONTALI FRONTS / FACADES / PUERTAS				
S22 SPAZIO	●		●	●
S22 QUARANTA5		●		
S22 TRATTO		●	●	
S22 LINEA		●	●	
S22 DIAGONAL		●	●	
ALU-TEK	●	●	●	

S22

COLONNE

TOWER UNITS / COLONNES / COLUMNAS

STILO



NEWTON



NEON



SLIM



TUBE 22



PONTE



INCA



FLOAT



FINITURE MANIGLIE

HANDLE FINISHES / FINITIONS DES POIGNÉES /
ACABADOS DE LOS TIRADORES

MANIGLIE
HANDLES / POIGNÉES / TIRADORES

FINITURE FINISHES / FINITIONS / ACABADOS	METAL "A - B"	LINEA	TRATTO	NEWTON	STILO	NEON	SLIM	TUBE 22	PONTE	INCA	FLOAT	ALLUMINIA	GOLA CONCAVA	GOLA PIATTA
ALLUMINIO SATINATO SATIN ALUMINIUM / ALUMINIUM SATINÉ / ALUMINIO SATINADO	●	●	●								●		●	●
ALLUMINIO BRUNITO DARK ALUMINIUM / ALUMINIUM BRUNI / ALUMINIO BRUÑIDO	●	●	●	●				●				●	●	●
ALLUMINIO BRILL ALUMINIUM BRILL / ALUMINIUM BRILL / ALUMINIO BRILL							●						●	●
BIANCO WHITE / BLANC / BLANCO	●	●	●	●			●						●	●
NICHEL SATINATO SATIN NICKEL / NICKEL SATINÉ / NÍQUEL SATINADO					●									
TITANIO TITANIUM / TITANE / TITANIO					●									
ACCIAIO STAINLESS STEEL / ACIER / ACERO				●		●		●	●	●				
LACCATO METALLESCENTE METALLIC LACQUERED / LAQUÉ METALLIC / LACADO METALIZADO													●	●
LACCATO OPACO MATT LACQUERED / LAQUÉ MAT / LACADO OPACO	●	●											●	●
LACCATO LUCIDO GLOSSY LACQUERED / LAQUÉ BRILLANT / LACADO BRILLANTE													●	●
LEGNO (Olmo - Rovere - Noce) WOOD: Elm - Oak - Walnut BOIS: Orme - Chêne - Noyer MADERA (Olmo - Roble - Nogal)														●

ELEMENTI CARATTERIZZANTI

CHARACTERIZING ELEMENTS /
ÉLÉMENTS DE CARACTÉRISATION /
ELEMENTOS CARACTERIZADORES

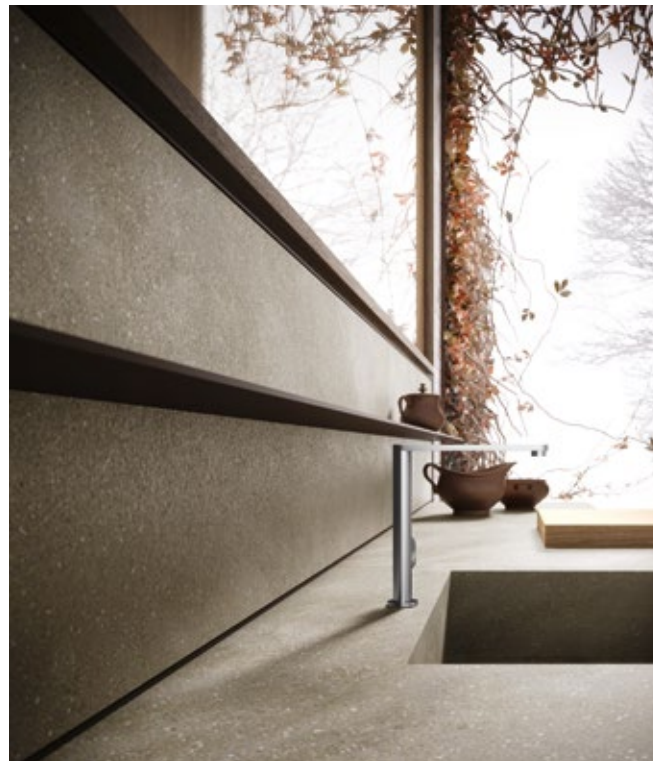

01.2023 - V.2

ITA_ L'ARMONIA DELL'INSIEME SI DEVE ALLE SOLUZIONI DI SEPARAZIONE E RACCORDO DEGLI SPAZI. ELEMENTI ATTREZZATI E PANNELLI LAVORATI GIOCANO CON I PIENI E I VUOTI, LA LUCE E LA PROSPETTIVA, IL VISIBILE E IL CELATO.

ENG_ The overall harmony is due to the solutions in separating and connecting spaces. Equipped elements and manufactured panels play with solids and voids, light and perspective, the visible and the concealed

FRA_ L'harmonie de l'ensemble est due aux solutions de séparation et de liaison des espaces. Les éléments équipés et les panneaux usinés jouent avec les pleins et les vides, la lumière et la perspective, le visible et le caché.

ESP_ La armonía del conjunto se debe a las soluciones de separación y conexión de espacios. Elementos empotrados y paneles mecanizados juegan con los sólidos y los vacíos, la luz y la perspectiva, lo visible y lo escondido.

S22

SNACK

BREAKFAST BAR / SNACK / SNACK



S22

TAVOLO SAGOMATO

SHAPED TABLE / TABLE AVEC FORM /
MESA MOLDEADO



TAVOLO IMPIALLACCIATO SAGOMATO, COMPLETO DI BASAMENTO

SHAPED VENEER TABLE, COMPLETE WITH BASE /
TABLE EN PLACAGE FAÇONNÉ, COMPLÈTE AVEC
STRUCTURE /
MESA CHAPADA EN FORMA, COMPLETA CON BASE

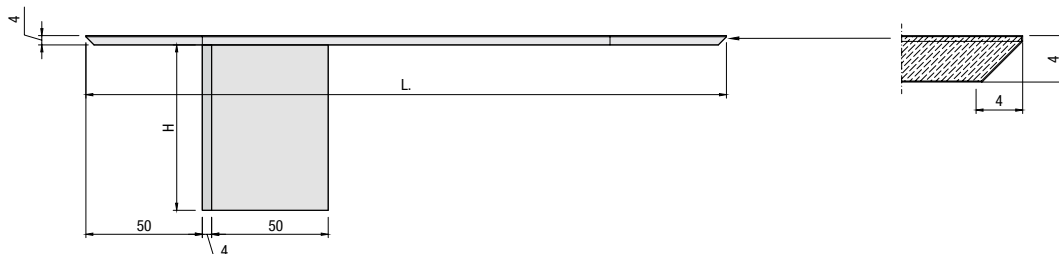
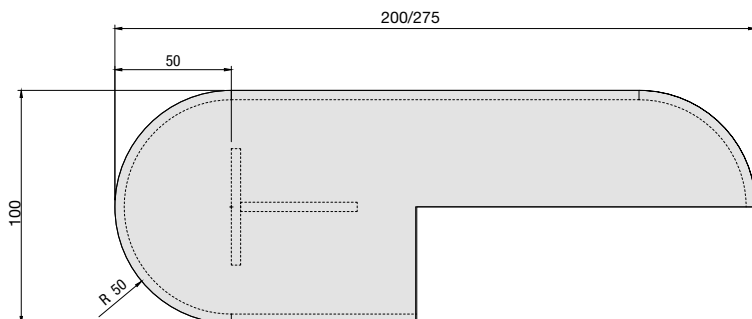
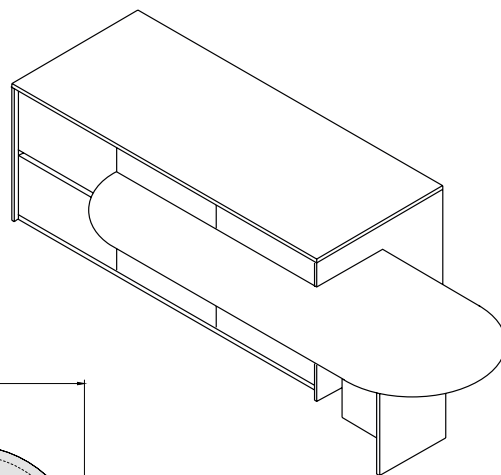

S22

SUPPORTI PER PIANI

SUPPORTS FOR TOPS / SUPPORT POUR SNACK /
SOPORTES PARA BARRA DE DESAYUNO

REGOLA PER PIANO A SBALZO

TECH SUGGESTIONS FOR CANTILEVERED TOP / RÈGLE TECHNIQUE POUR LE SUPPORT DES SNACK /
REGLA TECNICA PARA LA PARTE SUPERIOR EN VOLADIZO

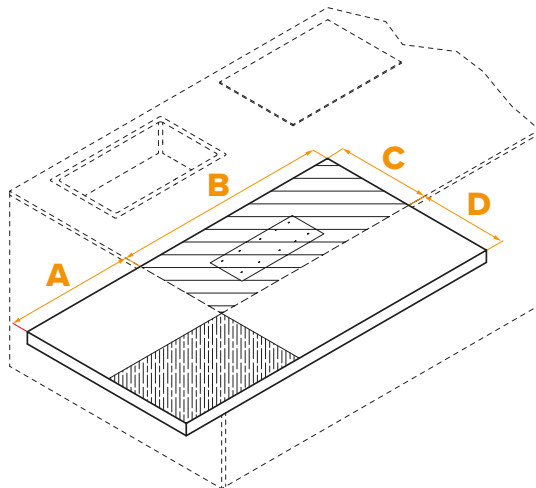

SUPERFICIE IN APPOGGIO

SUPPORTING SURFACE /
SURFACE D'APPUI /
SUPERFICIE DE APOYO

SUPERFICIE A SBALZO

CANTILEVER SURFACE /
SURFACE EN PORTE-À-FAUX /
SUPERFICIE EN VOLADIZO



>



A = max 70 cm; C = min. 30 cm

PIANO FINITO NEI 4 LATI

SHELF FINISHED ON 4 SIDES /
PLAN FINI 4 CÔTÉS / PLAN FINI SUR 4 CÔTÉS /
ESTANTERÍA ACABADA EN 4 LADOS

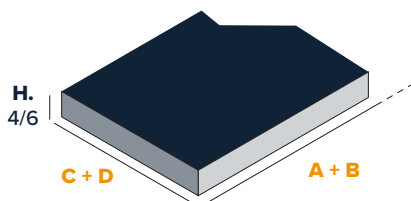

H. 4/6



PIANO SAGOMATO SU 4 LATI

SHELF SHAPED ON 4 SIDES /
PLAN AVEC FACONAGE SUR 4 CÔTÉS /
ESTANTERÍA CON CANTO MOLDEADO EN 4 LADOS

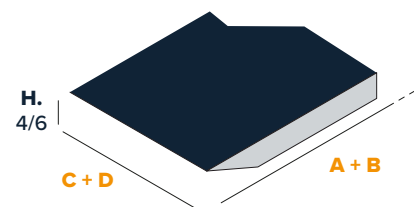

H. 4/6

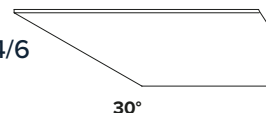

30°

S22

SNACK ESTRAIBILE

PULL-OUT SNACK / SNACK EXTRACTIBLE /
MESA SNACK EXTRACTIBLE

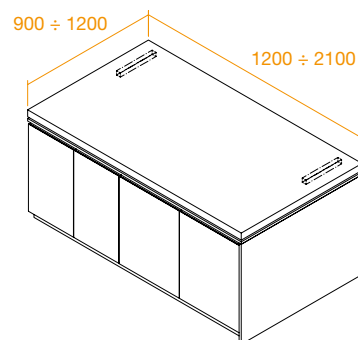
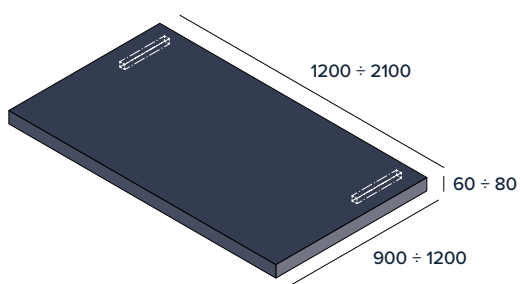

PIANO SNACK PER MECCANISMO ESTRAIBILE COMPLETO DI GUIDE TELESCOPICHE

SNACK TOP FOR PULL-OUT MECHANISM COMPLETE
WITH TELESCOPIC GUIDES

PLATEAU SNACK POUR LE MÉCANISME D'EXTRACTION
AVEC GUIDES TÉLESCOPIQUES

ENCIMERA PARA EL MECANISMO DE EXTRACCIÓN
COMPLETA CON GUÍAS TELESCÓPICAS

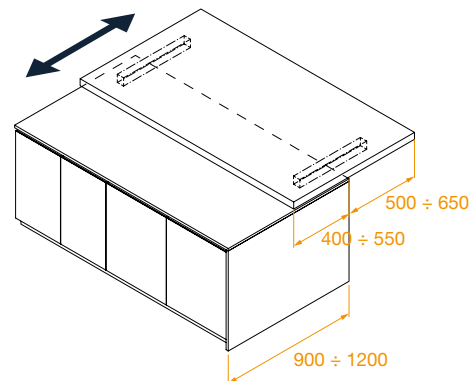

S22

SNACK A SBALZO

OVERHANG SNACK / SNACK PORTE A FAUX /

BARRA SNACK SOBREPUESTO

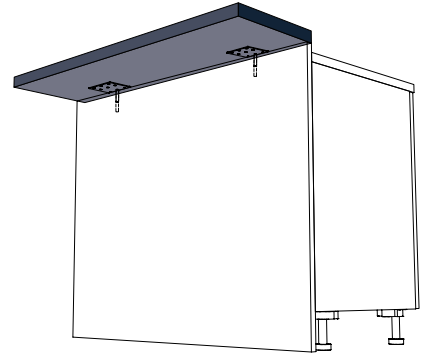

PIANO FINITO NEI 4 LATI

TOP FINISHED ON 4 SIDES /
SNACK FINI SUR 4 CÔTÉS /
ACABADO BIEN EN 4 LADOS

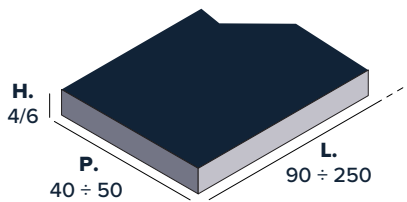

H. 4/6



PIANO SAGOMATO SU 2/3 LATI

TOP SHAPED ON 2/3 SIDES /
SNACK AVEC FACONAGE SUR 2/3 CÔTÉS /
CANTO MOLDEADO EN 2/3 LADOS

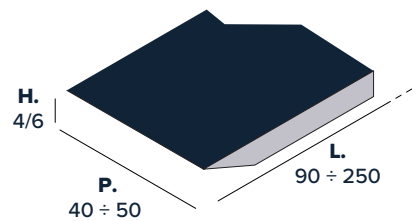

H. 4/6

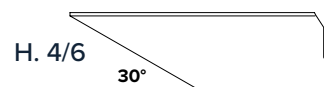

S22

MECCANISMI ESTRAIBILI

PULL-OUT MECHANISMS / MÉCANISME EXTRACTIBLE /

MECANISMOS DE EXTRACCIÓN

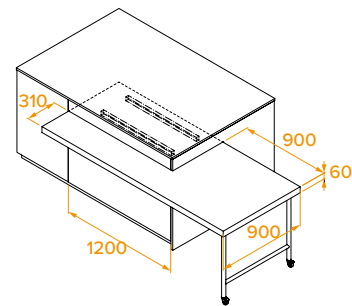
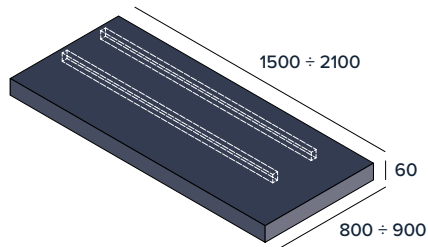

PIANO TAVOLO PER MECCANISMO ESTRAIBILE COMPLETO DI GUIDE TELESCOPICHE

COUNTERTOP FOR PULL-OUT MECHANISM
COMPLETE WITH TELESCOPIC RUNNERS

PLAN DE TRAVAIL POUR MÉCANISME EXTRACTIBLE
AVEC GUIDES TÉLESCOPIQUES

ENCIMERA PARA EL MECANISMO DE EXTRACCIÓN
COMPLETO CON GUÍAS TELESCÓPICAS

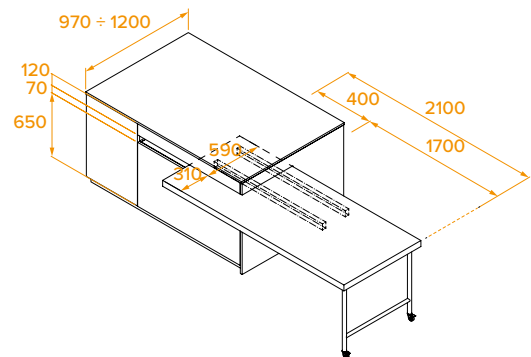

S22

SUPPORTI PER PIANI

COUNTERTOP SUPPORTS / SUPPORTS POUR SNACK /
 SOPORTES PARA BARRA SNACK

GAMBONE SNAKE INOX

"SNAKE" STAINLESS
 STEEL LEG /
 PIED « SNAKE » EN ACIER
 INOXYDABLE /
 PATA "SNAKE" EN ACERO
 INOXIDABLE

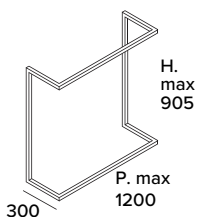

GAMBONE QUADRO TELESCOPICO

"QUADRO" TELESCOPIC LEG /
 PIED CARRÉE TÉLESCOPIQUE /
 PATA "QUADRO" TELESCÓPICA

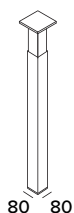

GAMBONI IN METALLO CON PIEDINI

METAL LEGS WITH FEET /
 PIEDS EN MÉTAL AVEC PIEDS /
 PATAS METÁLICAS CON PIES

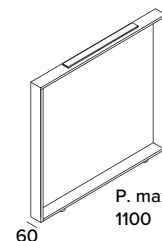
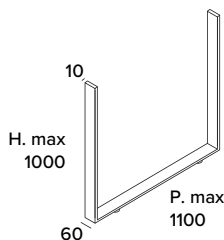

GAMBONE BRERA IN LEGNO

BRERA WOODEN LEG / PIED DE BOIS BRERA /
 PATA EN MADERA "BRERA"

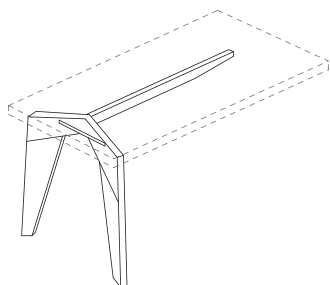

GAMBONE IN METALLO

METAL LEG / PIED DE MÉTAL /
 PATA DE METAL

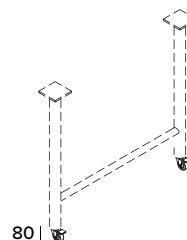
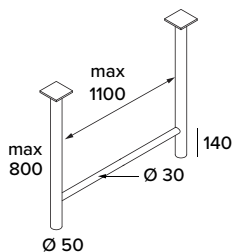

GAMBONE KRISTALL IN VETRO

"KRISTALL" GLASS LEG / PIED DE VERRE KRISTALL /
 PATA DE CRISTAL "KRISTALL"

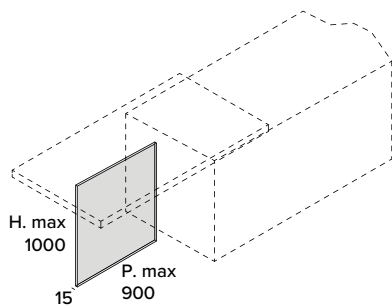

S22

FINITURE PIANI SNACK

BREAKFAST BAR FINISHES / LES FINITIONS POUR SNACK /

ACABADOS BARRA SNACK

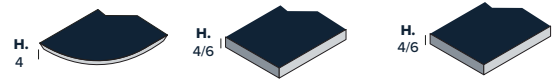

	H. 4 cm	H. 4 cm	H. 6 cm	H. 4 cm	H. 6 cm
LAMINATO HPL HPL LAMINATE / HPL LAMINATE / LAMINADO HPL		●	●	●	●
LAMICOLOR LAMICOLOR / LAMICOLOR / LAMICOLOR		●	●	●	●
LACCATO OPACO MATT LACQUERED / LAQUE MAT / LACADO MATE		●	●	●	●
FENIX FENIX / FENIX / FENIX		●	●	●	●
FENIX HAMILTON - DUKAT - CORTEZ FENIX HAMILTON - DUKAT - CORTEZ / FENIX HAMILTON - DUKAT - CORTEZ / FENIX HAMILTON - DUKAT - CORTEZ		●	●	●	●
ROVERE OAK / CHÊNE / ROBLE	●	●	●	●	●
ROVERE TERMOCOTTO "TERMOCOTTO" OAK / CHÊNE TERMOSTRUCTURE' / ROBLE TÉRMOCOTTO	●	●	●	●	●
OLMO ELM / OLMO / OLM	●	●	●	●	●
NOCE CANALETTO CALDO / CRUDO WARM / RAW CANALETTO WALNUT / NOYER CANALETTO CALDO / CRUDO / NUEZ CANALETTO CALIENTE / CRUDA	●	●	●	●	●
ABETE INVECCHIATO AGED FIR WOOD / SAPIN VIELLI / SPRUCE EVEJECIDO	●	●	●	●	●
ROVERE HERITAGE HERITAGE OAK / CHÊNE HERITAGE / ROBLE HERITAGE	●	●	●	●	●



Non disponibile in alcune finiture, consultare il listino.

Not available in certain finishes, see price list.

Pas disponible dans certaines finitions, voir liste des prix.

No disponible en algunos acabados, ver lista de precios.

S22

BOISERIE

BOISERIE / BOISERIE / BOISERIE



01.2023 - V.2



S22

BOISERIE

BOISERIE / BOISERIE / BOISERIE



KIT COMPRENSIVO DI PROFILO SUPERIORE, BARRA REGGIPENSILE E PANNELLO

TOP FINISHED ON 4 SIDES /
SNACK FINI SUR 4 CÔTÉS /
ACABADO BIEN EN 4 LADOS

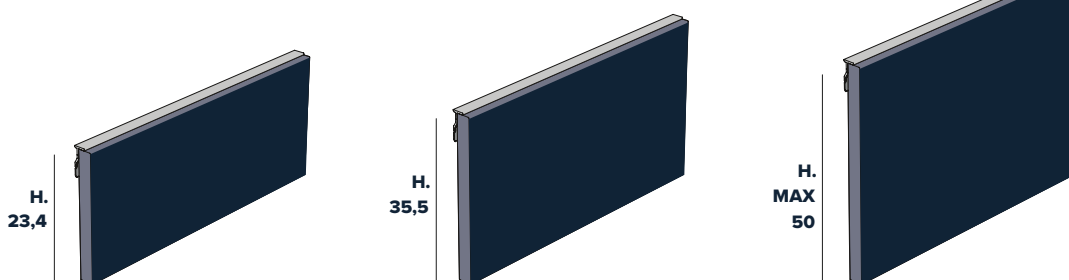

KIT COMPRENSIVO DI PROFILO INTERMEDIO, E PANNELLO

TOP FINISHED ON 4 SIDES /
SNACK FINI SUR 4 CÔTÉS /
ACABADO BIEN EN 4 LADOS

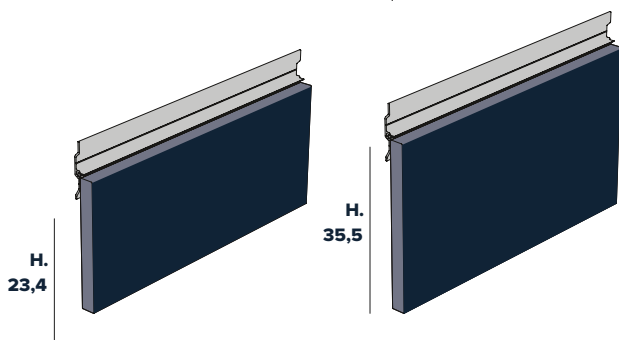

KIT COMPRENSIVO DI PROFILO INFERIORE, PROFILO INTERMEDIO E PANNELLO H. MAX 50

TOP FINISHED ON 4 SIDES /
SNACK FINI SUR 4 CÔTÉS /
ACABADO BIEN EN 4 LADOS

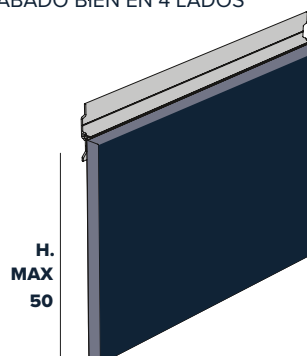

S22

BOISERIE

BOISERIE / BOISERIE / BOISERIE

PROFILO SUPERIORE

TOP PROFILE /
PROFIL SUPÉRIEUR /
PERFIL SUPERIOR



PROFILO INFERIORE

BOTTOM PROFILE /
PROFIL INFÉRIEUR /
PERFIL INFERIOR



PROFILO INTERMEDIO

MIDDLE PROFILE /
PROFIL INTERMÉDIAIRE /
PERFIL INTERMEDIO



PROFILO LATERALE

SIDE PROFILE /
PROFIL LATÉRAL /
PERFIL LATERAL

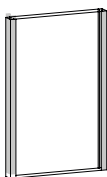

TAPPI

CAPS /
BOUCHONS /
MAYÚSCULAS



MENSOLA

SHELVE /
ÉTAGÈRE /
MENSOLA



MENSOLA PORTA CALICI

GOBLET HOLDER SHELVES /
ÉTAGÈRE PORTE VERRES /
ESTANTE PARA GLOBOS

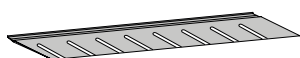

SET 4 GANCI

SET OF 4 HOOKS /
SET DE 4 CROCHETS /
SET 4 GANCHOS

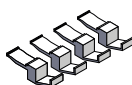

PORTA SCOTTEX

TOWELS HOLDER /
PORTE ESSUIE TOUT /
SOPORTE PARA PAPIEL

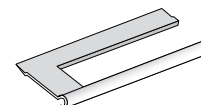

PORTA I-PAD

I-PAD HOLDER /
PORTE I-PAD /
SOPORTE PARA I-PAD

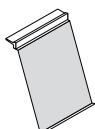

PORTA COLTELLI

KNIVES HOLDER /
PORTE COUTEAUX /
SOPORTE PARA CUCHILLOS

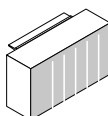

S22
BOISERIE
BOISERIE / BOISERIE / BOISERIE



	PANNELLI	PROFILI
LAMINATO MELAMINICO MELAMINE LAMINATED STRATIFIÉ MÉLAMINE LAMINADO DE MELAMINA	•	
MELAMINICO TERMOSTRUTTURATO TERMOSTRUTTURATO MELAMINE LAMINATED MÉLAMINÉ THERMOSTRUCTURÉ LAMINADO "TERMOSTRUTTURATO"	•	
PET	•	
LAMICOLOR	•	
FENIX	•	
LACCATO OPACO MATT LACQUERED LAQUÉ MAT LACADO MATE	•	
LACCATO LUCIDO GLOSSY LACQUERED LAQUÉ BRILLANT LACADO BRILLANTE	•	
MDI INALCO	•	
LACCATO METALLESCENTE METALLIC LACQUERED LAQUÉ METALLIC LACADO EFECTO METAL	•	
LACCATO METALLESCENTE ANTICATO METALLIC BRUSHED LACQUERED LAQUÉ METALLIC BROSSÉ LACADO EFECTO METAL CEPILLADO	•	
TECHNIK GLASS	•	
LEGNO WOODS BOIS MADERA	•	
VETRO LACCATO SATINATO FROSTED GLASS LACQUERED VERRE LAQUÉ SATINÉ VIDRIO LACADO MATE	•	
VETRO LACCATO LUCIDO GLOSSY GLASS LACQUERED VERRE LAQUÉ BRILLANT VIDRIO LACADO BRILLANTE	•	
LAMINAM	•	
ALLUMINIO SPAZZOLATO NERO BRUSHED ALUMINIUM BLACK ALUMINIO NOIR BROSSÉ ALUMINIO SATINADO NEGRO		•



S22

RASTER

RASTER / RASTER / RASTER



S22

RASTER

RASTER / RASTER / RASTER

MODULARITÀ

MODULARITY / MODULARITÉ / MODULARIDAD

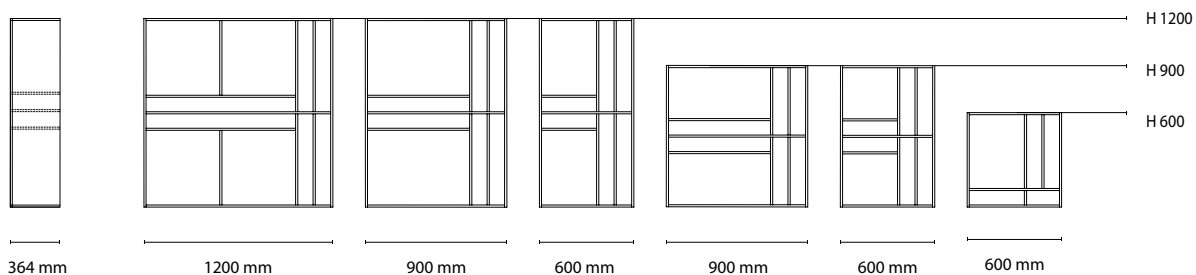

RASTER MONOFACCIALE E BIFACCIALE

SINGLE-SIDED RASTER & DOUBLE-SIDED /

NICHE RASTER 1 FACE & DOUBLE FACE /

RASTER DE UNA Y DOBLE CARAS

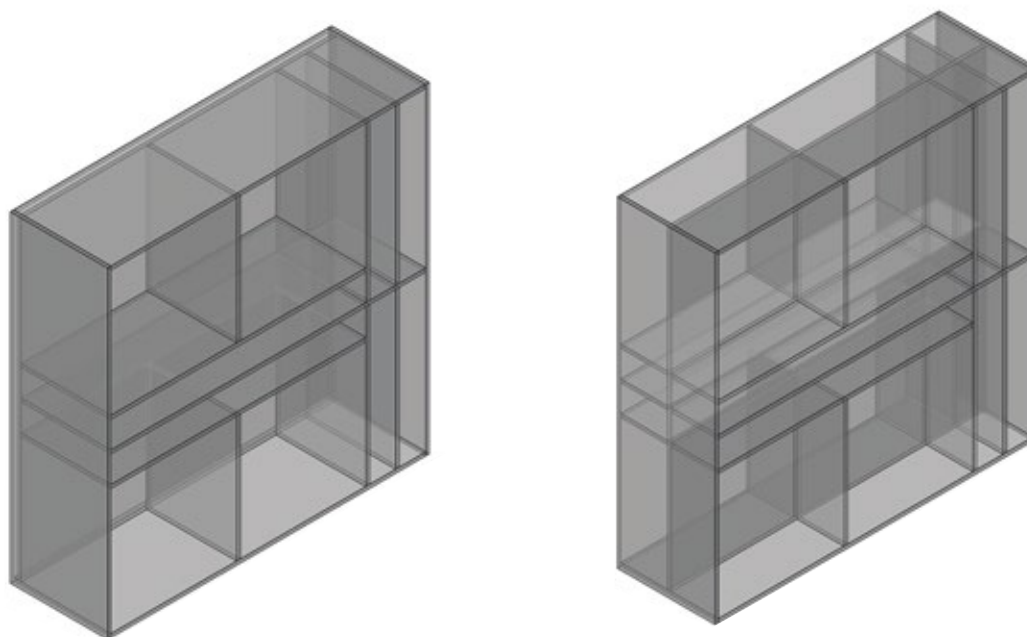

S22
RASTER
 RASTER / RASTER / RASTER

RASTER

<p>LACCATO OPACO MATT LACQUERED LAQUÉ MAT LACADO MATE</p>	●
<p>LACCATO LUCIDO GLOSSY LACQUERED LAQUÉ BRILLANT LACADO BRILLANTE</p>	●
<p>LACCATO METALLESCENTE METALLIC LACQUERED LAQUÉ METALLIC LACADO EFECTO METAL</p>	●
<p>ROVERE OAK CHÊNE ROBLE</p>	●



S22

FRONTALI

FRONTS / FACADES / PUERTAS



01.2023 - V.2

ITA_ Lo spessore delle ante da 22 mm: la caratteristica che ci contraddistingue. Il nostro Sistema 22.2 offre varie possibilità di personalizzazione su ante e frontali facendo particolare attenzione ad ergonomia e design.

ENG_ The 22 mm door thickness: the feature that sets us apart. Our Sistema 22.2 offers various possibilities for customisation of doors and fronts, paying particular attention to ergonomics and design.

FRA_ L'épaisseur des portes de 22 mm : la caractéristique qui nous distingue. Notre SISTEMA 22.2 offre diverses possibilités de personnalisation des portes et des façades en accordant une attention particulière à l'ergonomie et au design.

ESP_ El grosor de las puertas de 22 mm: la característica que nos distingue. Nuestro Sistema 22.2 ofrece varias posibilidades de personalización en puertas y frentes prestando especial atención a la ergonomía y el diseño.

S22

FRONTALI

FRONTS / FACADES / PUERTAS

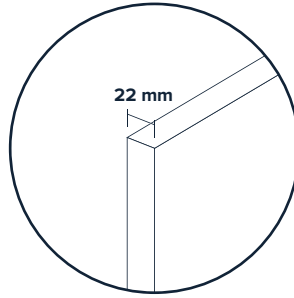

S22 SPAZIO



S22 METAL

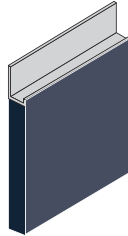

S22 BRERA



S22 TRATTO

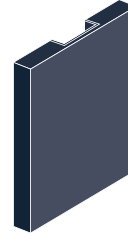

S22 LINEA



S22 DIAGONAL



S22 QUARANTA5



01.2023 - V.2

TIPOLOGIE APERTURE

OPENING METHODS /
TYPE D'OUVERTURE /
TIPO DE APERTURA
DE LA PUERTA

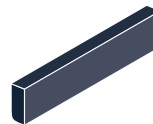

FRONTALI FRONTS / FACADES / PUERTAS	PUSH PULL PUSH PULL PUSH PULL PUSH PULL	GOLA PIATTA FLAT GRIP GROOVE GORGE PLATE RANURA PLANA	GOLA CONCAVA CONCAVE GRIP-GROOVE GORGE CONCAVE RANURA CONCAVA	MANIGLIA HANDLE POIGNEE TIRADOR
S22 SPAZIO	●		●	●
S22 QUARANTA5		●		
S22 TRATTO		●	●	
S22 LINEA		●	●	
S22 DIAGONAL		●	●	

S22

MODULARITÀ

MODULARITY / MODULARITÉ / MODULARIDAD

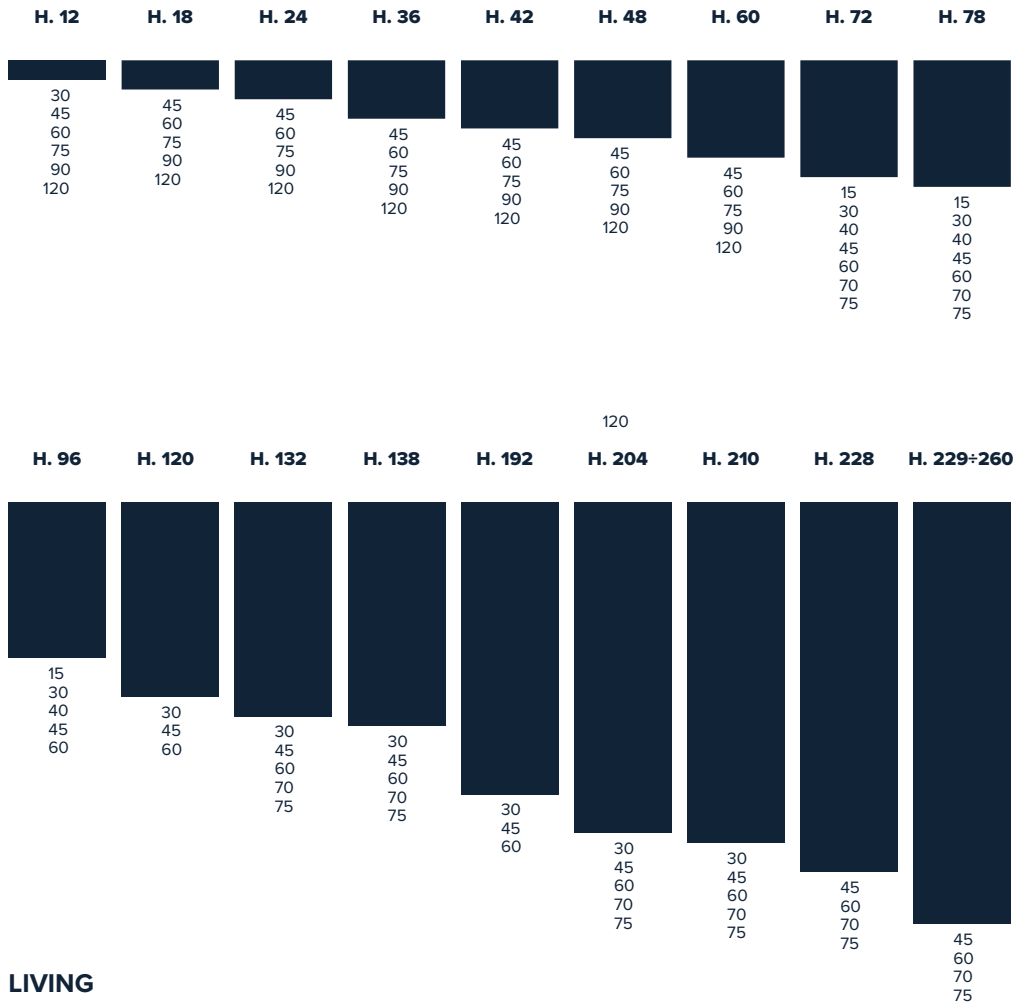

LIVING

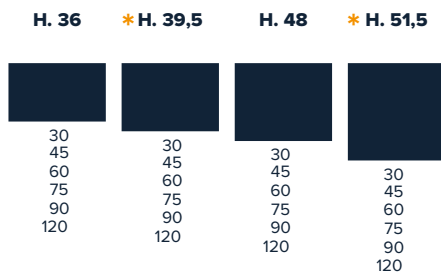

* CON GOLA / WITH GROOVE / AVEC GORGE / CON RANURA

TELAIA

FRONTALI

FRONTS / FACADES / PUERTAS

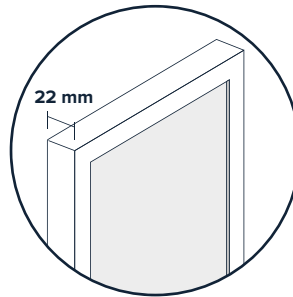

TELAIA



01.2023 - V.2

TIPOLOGIE APERTURE

OPENING METHODS /
 TYPE D'OUVERTURE /
 TIPO DE APERTURA
 DE LA PUERTA

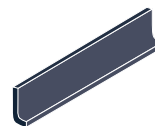

	PUSH PULL PUSH PULL PUSH PULL PUSH PULL	GOLA CONCAVA CONCAVE GRIP-GROOVE GORGE CONCAVE RANURA CONCAVA	MANIGLIA HANDLE POIGNEE TIRADOR
FRONTALI FRONTS / FACADES / PUERTAS			
TELAIA SPAZIO	●	●	●

TELAIA

MODULARITÀ

MODULARITY / MODULARITÉ / MODULARIDAD

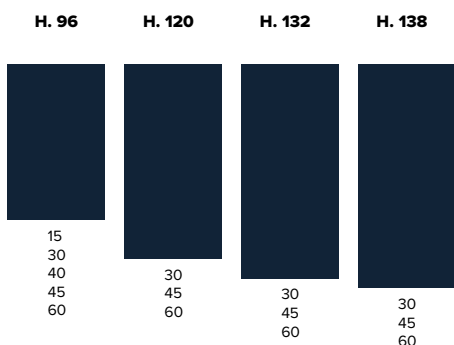
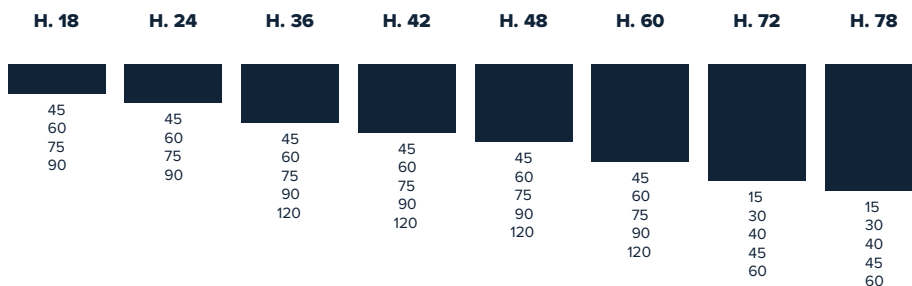

LIVING

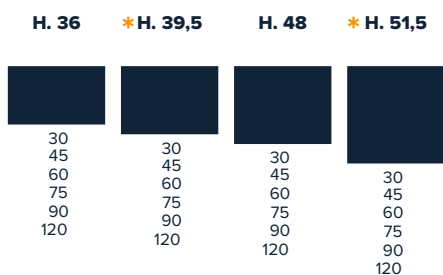

* CON GOLA / WITH GROOVE / AVEC GORGE / CON RANURA

ALU-TEK

FRONTALI

FRONTS / FACADES / PUERTAS

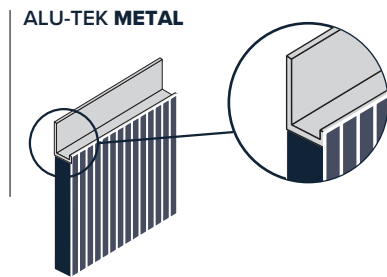
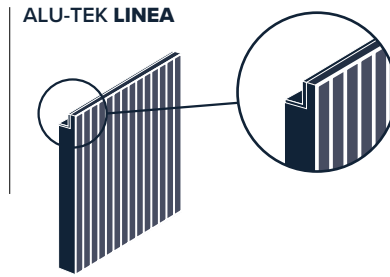
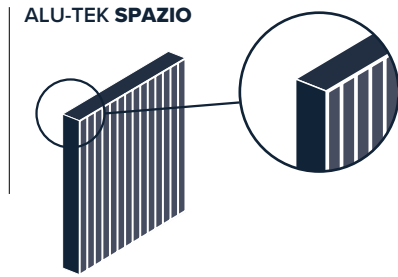
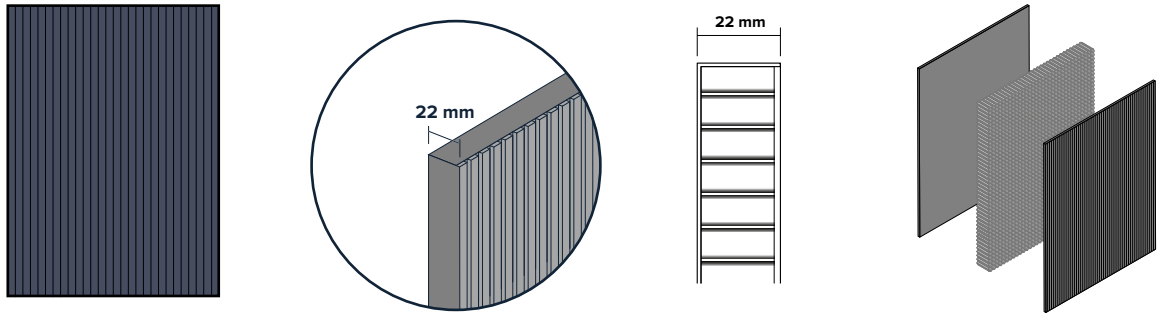

01.2023 - V.2

TIPOLOGIE APERTURE

OPENING METHODS /
 TYPE D'OUVERTURE /
 TIPO DE APERTURA
 DE LA PUERTA

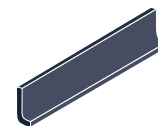
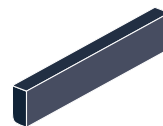

FRONTALI FRONTS / FACADES / PUERTAS	PUSH PULL PUSH PULL PUSH PULL PUSH PULL	GOLA PIATTA FLAT GRIP GROOVE GORGE PLATE RANURA PLANA	GOLA CONCAVA CONCAVE GRIP-GROOVE GORGE CONCAVE RANURA CONCAVA
ALU-TEK SPAZIO	●		●
ALU-TEK LINEA		●	●

ALU-TEK

MODULARITÀ

MODULARITY / MODULARITÉ / MODULARIDAD

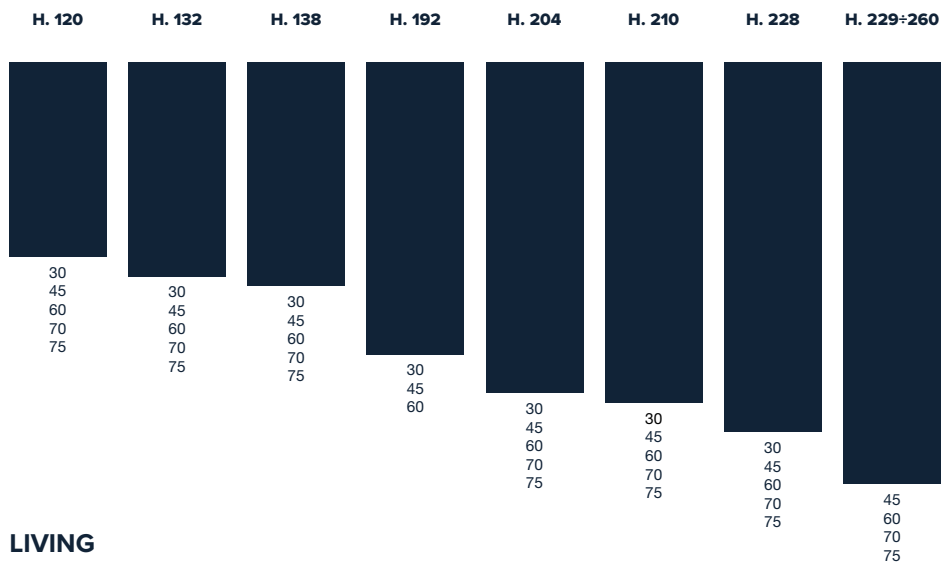
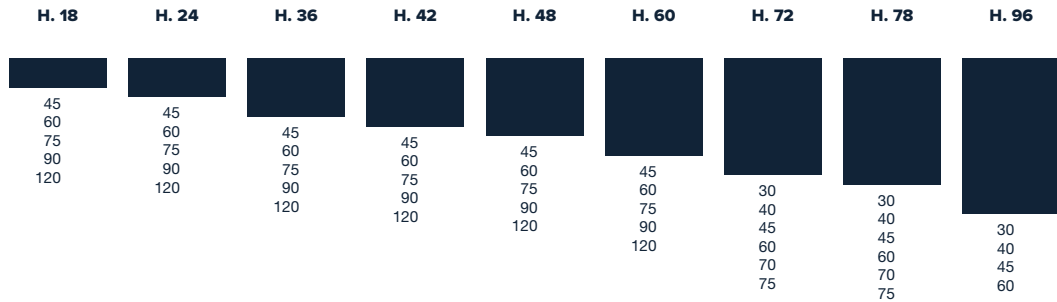

LIVING

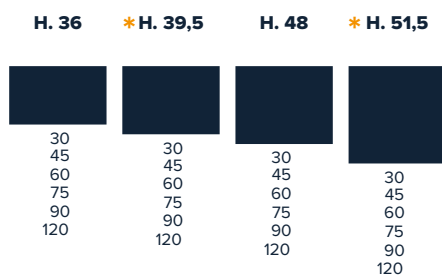

* CON GOLA / WITH GROOVE / AVEC GORGE / CON RANURA

ALU-BOX

FRONTALI

FRONTS / FACADES / PUERTAS

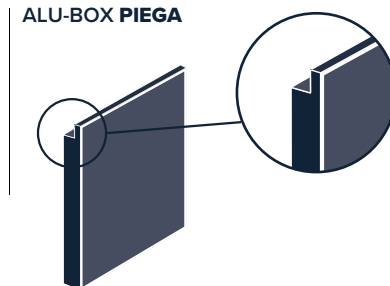
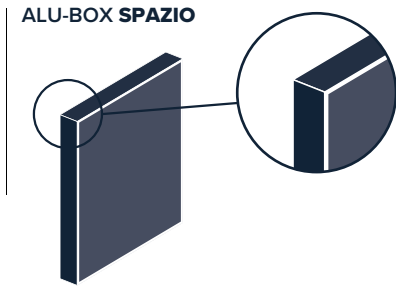
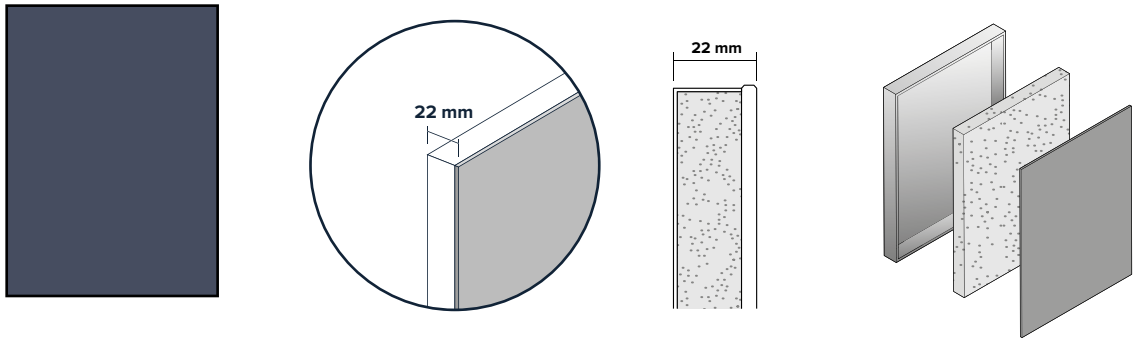

TIPOLOGIE APERTURE

OPENING METHODS /
 TYPE D'OUVERTURE /
 TIPO DE APERTURA
 DE LA PUERTA

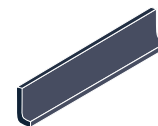
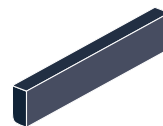

FRONTALI FRONTS / FACADES / PUERTAS	PUSH PULL PUSH PULL PUSH PULL PUSH PULL	GOLA PIATTA FLAT GRIP GROOVE GORGE PLATE RANURA PLANA	GOLA CONCAVA CONCAVE GRIP-GROOVE GORGE CONCAVE RANURA CONCAVA
ALU-BOX SPAZIO	●		●
ALU-BOX PIEGA		●	●

ALU-BOX

MODULARITÀ

MODULARITY / MODULARITÉ / MODULARIDAD

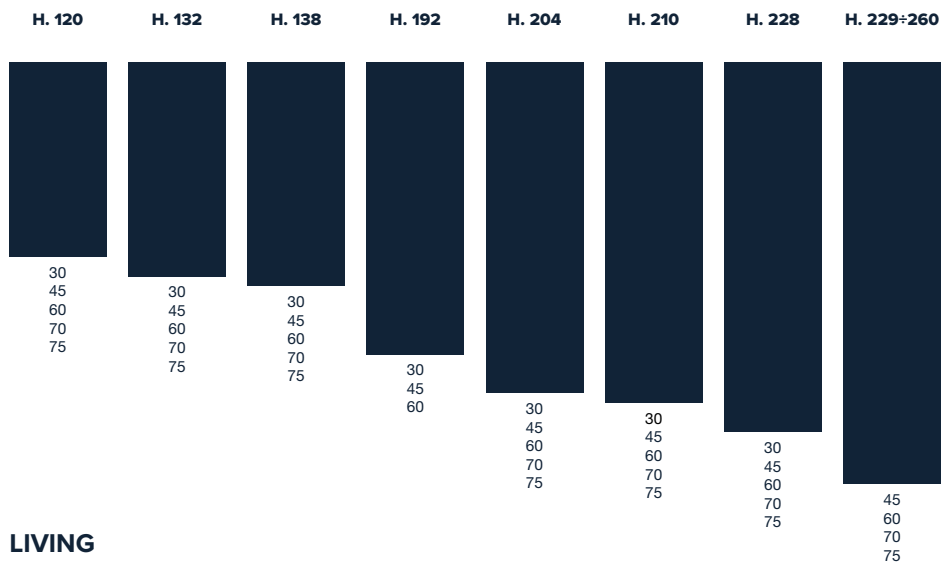
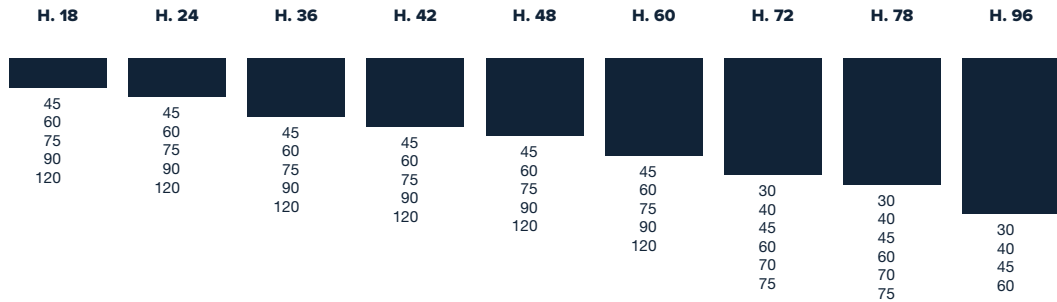

LIVING

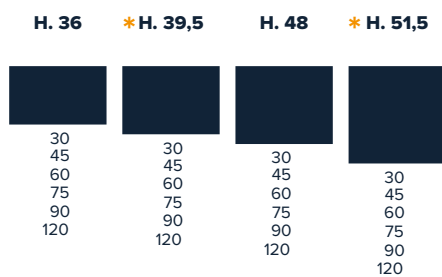

* CON GOLA / WITH GROOVE / AVEC GORGE / CON RANURA

ALLUMINIA

FRONTALI

FRONTS / FACADES / PUERTAS

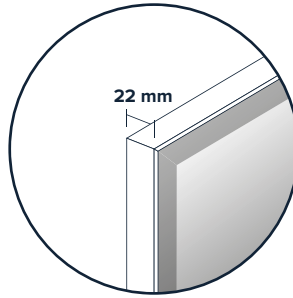

ALLUMINIA SPAZIO

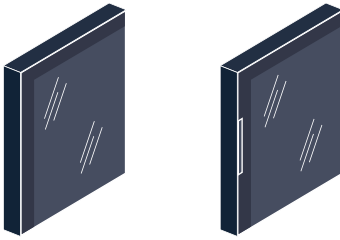

01.2023 - V.2

TIPOLOGIE APERTURE

OPENING METHODS /
 TYPE D'OUVERTURE /
 TIPO DE APERTURA
 DE LA PUERTA

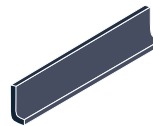

	PUSH PULL PUSH PULL PUSH PULL PUSH PULL	GOLA CONCAVA CONCAVE GRIP-GROOVE GORGE CONCAVE RANURA CONCAVA	MANIGLIA HANDLE POIGNEE TIRADOR
FRONTALI FRONTS / FACADES / PUERTAS			
ALLUMINIA SPAZIO	●	●	●

ALLUMINIA

MODULARITÀ

MODULARITY / MODULARITÉ / MODULARIDAD

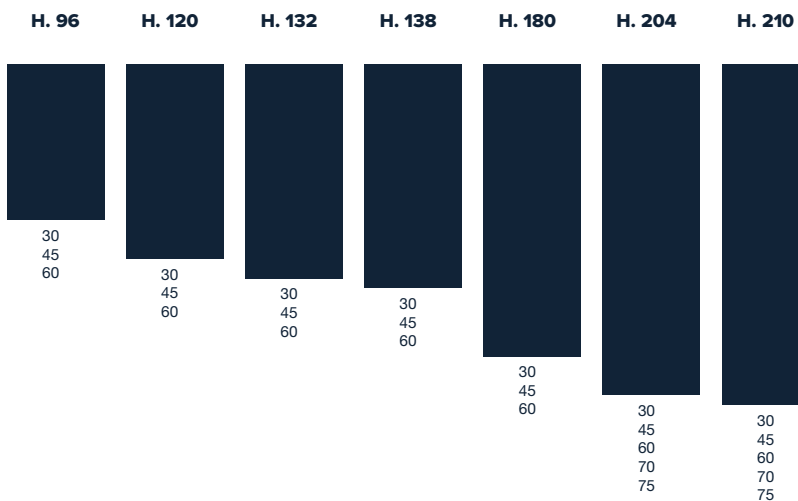
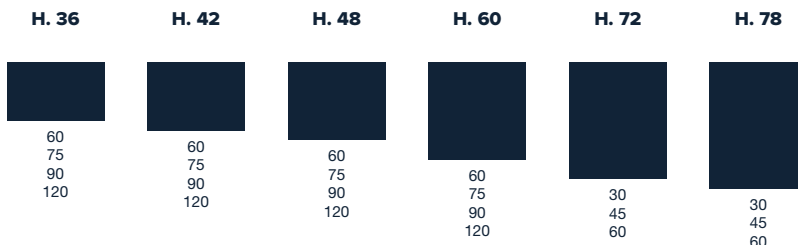

LIVING

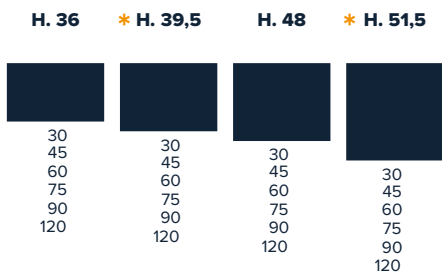

* CON GOLA / WITH GROOVE / AVEC GORGE / CON RANURA

S22.2

FINITURE FRONTALI

FRONTS FINISHES / FINITIONS FACADES / ACABADOS PUERTAS

	S22							TELAIA	ALU-BOX		ALLUMINIA	ALU-TEK		
	SPAZIO	METAL	BRERA	TRATTO	LINEA	DIAGONAL	QUARANTAS	SPAZIO	SPAZIO	PIEGA	SPAZIO	SPAZIO	LINEA	METAL
LAMINATO MELAMINICO MELAMINE LAMINATED STRATIFIÉ MÉLAMINE LAMINADO DE MELAMINA	•	•		•	•	•								
PET	•	•		•	•									
LAMINATO HPL HPL LAMINATE STRATIFIÉ HPL LAMINADO HPL	•	•		•	•	•	•							
LAMICOLOR	•	•		•	•	•	•							
FENIX	•	•		•	•	•	•							
LACCATO OPACO MATT LACQUERED LAQUÉ MAT LACADO MATE	•	•	•	•	•	•	•	•						
LACCATO LUCIDO GLOSSY LACQUERED LAQUÉ BRILLANT LACADO BRILLANTE	•	•	•	•	•	•	•							
LACCATO A CAMPIONE AS SAMPLE LACQUERED COULEURS PERSONALISÉS LAQUÉ LACADO SOBRE MUESTRA DE COLOR	•	•	•	•	•	•	•							
LACCATO METALLESCENTE METALLIC LACQUERED LAQUÉ METALLIC LACADO EFECTO METAL	•	•	•	•	•	•	•							
LACCATO METALLESCENTE ANTICATO METALLIC BRUSHED LACQUERED LAQUÉ METALLIC BROSSÉ LACADO EFECTO METAL CEPILLADO	•	•	•	•	•	•	•							
TECHNIK GLASS	•	•	•	•	•	•	•							
LEGNO WOODS BOIS MADERA	•	•	•	•	•	•	•							
VETRO LACCATO SATINATO FROSTED GLASS LACQUERED VERRE LAQUÉ SATINÉ VIDRIO LACADO MATE									•	•				
VETRO LACCATO LUCIDO GLOSSY GLASS LACQUERED VERRE LAQUÉ BRILLANT VIDRIO LACADO BRILLANTE									•	•				
LAMINAM									•	•				
SUPPORTI IN ALLUMINIO / STOPSOL ALUMINIUM SUPPORT / STOPSOL SUPPORT EN ALUMINIUM / STOPSOL SOPORTES DE ALUMINIO / VIDRIO STOPSOL											•			
ROVERE HERITAGE HERITAGE OAK CHÊNE HERITAGE ROBLE HERITAGE	•	•	•	•	•	•	•					•	•	•



S22

PENSILI

WALL UNITS / MEUBLES HAUTS / COLGANTES



01.2021 - V.1

IT_ Spazi che contengono. I pensili, personalizzabili in altezza, larghezza e profondità come le basi grazie al nostro Sistema 22, sono degli elementi di design ma allo stesso tempo funzionali a completamento della cucina. Manuali o motorizzati come i meccanismi Servo Drive o il pensile "Air".

ENG_ Spaces that contain. The wall units, which can be customised in height, width and depth like the base units thanks to our Sistema 22, are design yet functional elements that complete the kitchen. Manual or motorised, such as the Servo Drive mechanisms or the "Air" wall unit.

FRA_ Des espaces qui contiennent. Les éléments hauts, qui peuvent être personnalisés en hauteur, largeur et profondeur comme les éléments bas grâce à notre Sistema 22, sont des éléments design et fonctionnels qui complètent la cuisine. Manuel ou motorisé comme les mécanismes de Servo Drive ou le meuble haut «Air».

ESP_ Espacios que contienen. Los colgantes, que se pueden personalizar en altura, anchura y profundidad al igual que los muebles bajos gracias a nuestro Sistema 22, son elementos de diseño y funcionales que completan la cocina. Manual o motorizado como los mecanismos Servo Drive o el colgante "Air".

S22

PENSILI

WALL UNITS / MEUBLES HAUTS / COLGANTES

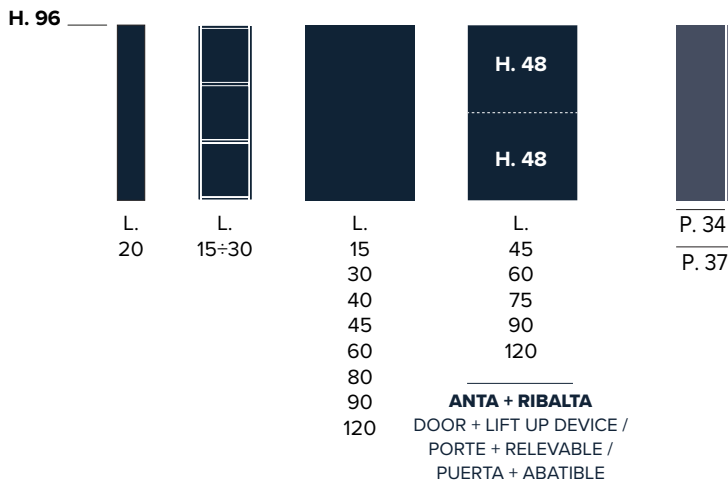
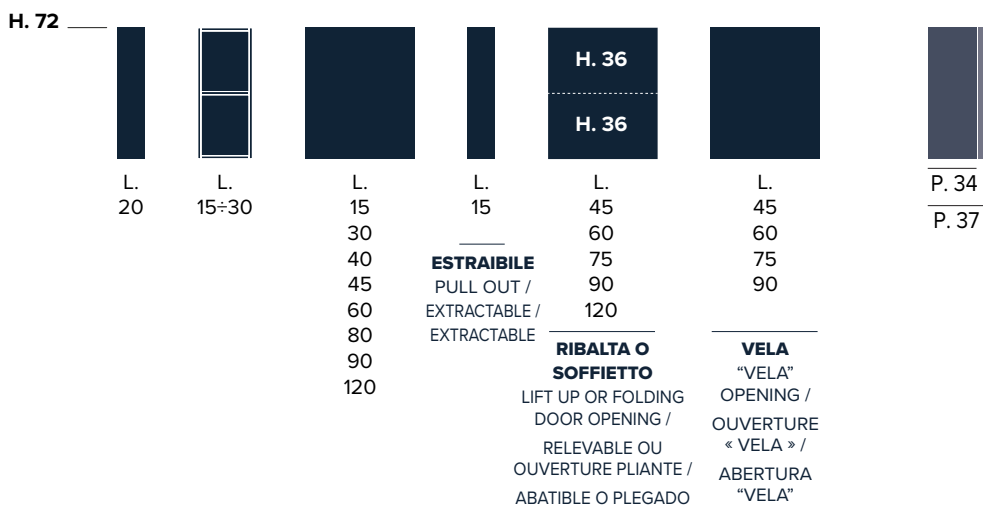
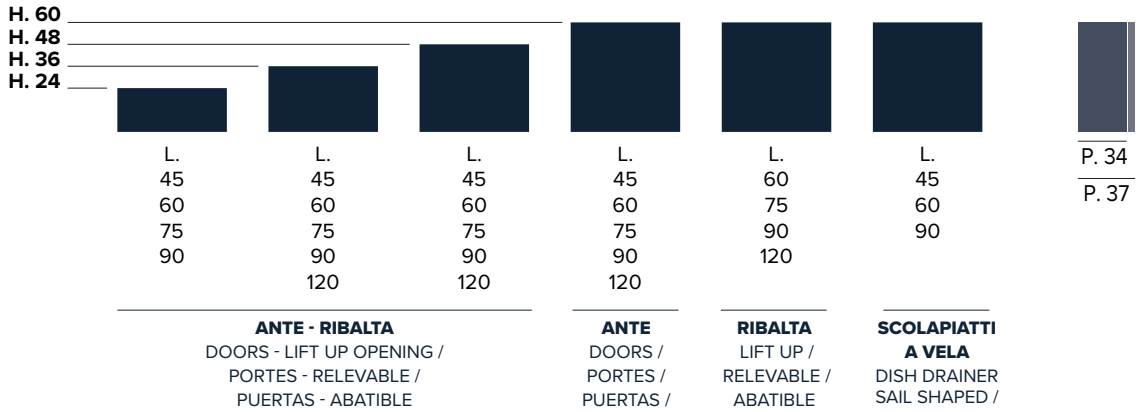

S22

PENSILI

WALL UNITS / MEUBLES HAUTS / COLGANTES

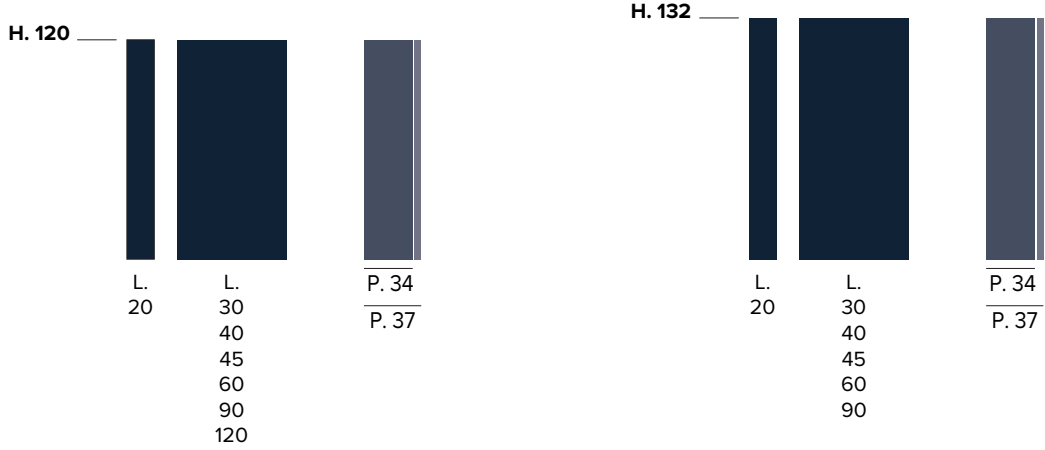

TIPOLOGIE APERTURE

OPENING METHODS / TYPES D'OUVERTURE / TIPOS DE ABERTURA

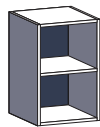

A GIORNO
 OPEN CABINET /
 MEUBLE OUVERT /
 MUEBLE ABIERTO

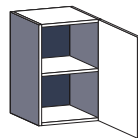

ANTE
 DOORS /
 PORTES /
 PUERTAS

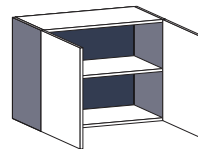

ANTE
 DOORS /
 PORTES /
 PUERTAS

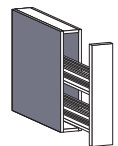

ESTRAIBILE
 PULL-OUT /
 EXTRAIBLE /
 EXTRACTABLE

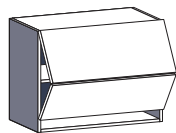

SOFFIETTO
 FOLDING DOOR /
 OUVERTURE PLIANTE /
 PLEGADO

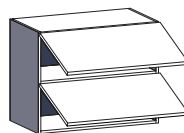

RIBALTA
 LIFT UP DOOR /
 RELEVABLE /
 ABATIBLE

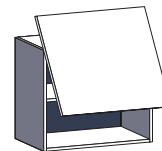

VELA
 "VELA" OPENING /
 OUVERTURE « VELA » /
 ABERTURA "VELA"

S22

PENSILI SISTEMA "AIR"

"AIR" SYSTEM WALL UNITS / MEUBLES HAUTS SYSTÈME "AIR" /

COLGANTE SISTEMA "AIR"

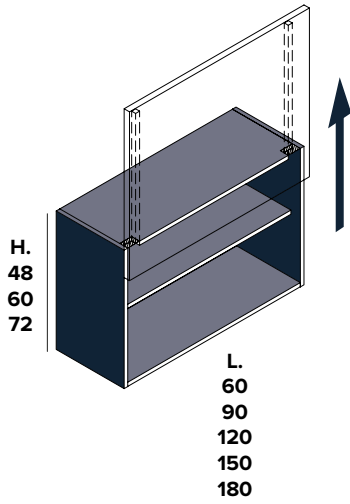

H. 48							
	L. 60	L. 90	L. 120	L. 150	L. 180	P. 34	P. 37
H. 60							
	L. 60	L. 90	L. 120	L. 150	L. 180	P. 34	P. 37
H. 72							
	L. 60	L. 90	L. 120	L. 150	L. 180	P. 34	P. 37

S22

PENSILI IN APPOGGIO SISTEMA "AIR"

"AIR" SYSTEM WALL UNITS LAYING ON COUNTERTOP /

MEUBLES HAUTS EN APPUI SYSTÈME « AIR » /

COLGANTE EN APOYO SISTEMA "AIR"

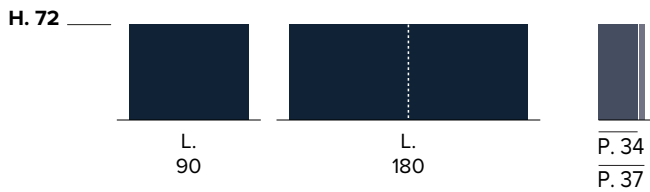
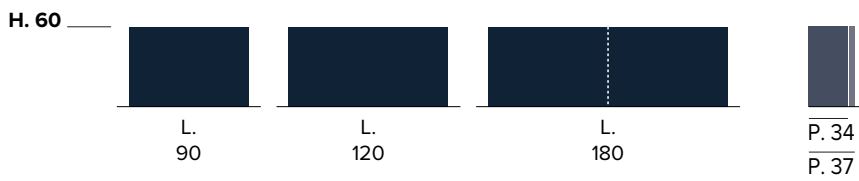
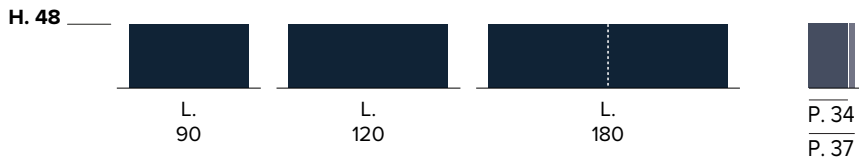
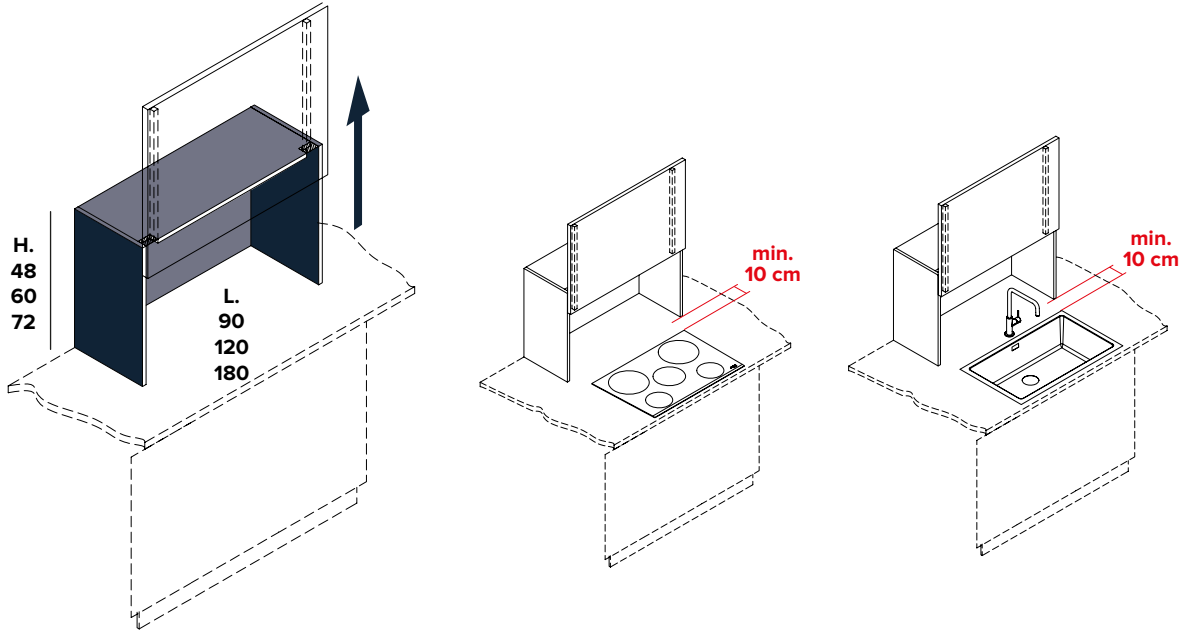

S22

MANIGLIE PER PENSILI

HANDLES FOR WALL UNITS / POIGNÉES POUR LES MEUBLES HAUTS /
TIRADORES PARA COLGANTES

PUSH



PUNTO

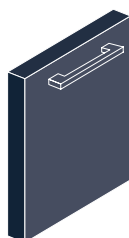

METAL "A"

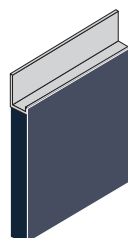

STILO



NEWTON



NEON



SLIM



TUBE 22



PONTE



INCA



S22

FINITURE MANIGLIE PER PENSILI

WALL UNIT HANDLES FINISHES / POIGNÉES DES MEUBLES HAUTS /
ACABADOS DE LOS TIRADORES PARA LOS COLGANTES

MANIGLIE
HANDLES / POIGNEE / TIRADORES

FINITURE FINISHES / FINITIONS / ACABADOS	METAL "A"	NEWTON	STILO	NEON	SLIM	TUBE 22	PONTE	INCA
ALLUMINIO SATINATO SATIN ALUMINIUM / ALUMINIUM SATINÉ / ALUMINIO SATINADO	●							
ALLUMINIO BRUNITO BURNISHED ALUMINIUM / ALUMINIUM BRUNI / ALUMINIO BRUÑIDO	●	●				●		
ALLUMINIO BRILL ALUMINIUM BRILL / ALUMINIUM BRILLANT / ALUMINIO BRILLANTE					●			
BIANCO WHITE / BLANC / BLANCO	●	●			●			
GRAU GRAU / GRAU / GRAU	●							
NICHEL SATINATO SATIN NICKEL / SATIN NICKEL / NÍQUEL SATINADO			●					
TITANIO TITANIUM / TITANIUM / TITANIO			●					
ACCIAIO STAINLESS STEEL / ACIER / ACERO		●		●		●	●	●
LACCATO OPACO MATT LACQUERED / LAQUE MAT / LACADO MATE	●							



S22

TOP - PIANI DI LAVORO

TOPS - WORKTOPS / TOPS - PLAN DE TRAVAIL / TOPS - ENCIMERAS

ALTA
ANOTHER VIEW



01.2021 - V:1

ITA_ L'ampia gamma di piani da lavoro di SISTEMA 22 spazia da una vasta scelta di laminati di alta qualità fino al prestigioso gres MDI di Inalco 12 mm. I diversi materiali si declinano in diversi spessori fino ai 40 mm del Lamicolor.

ENG_ The wide range of SISTEMA 22 worktops ranges from a wide selection of high quality laminates to the prestigious Inalco 12 mm MDI stoneware. The different materials are available in different thicknesses up to 40 mm Lamicolor.

FRA_ La large gamme de plans de travail SISTEMA 22 va d'un large choix de stratifiés de haute qualité au prestigieux grès MDI d'Inalco 12 mm . Les différents matériaux sont disponibles en différentes épaisseurs jusqu'à 40 mm de Lamicolor.

ESP_ La amplia gama de encimeras de SISTEMA 22 va desde una amplia selección de laminados de alta calidad hasta el prestigioso gres MDI de Inalco de 12 mm . Los diferentes materiales están disponibles en diferentes espesores hasta 40 mm de Lamicolor.

S22

TOP - PIANI DI LAVORO

TOPS - WORKTOPS / TOPS - PLAN DE TRAVAIL / TOPS - ENCIMERAS









TIPOLOGIE TOP

TOP TYPES / TYPES /
TIPOS SUPERIORES



FINITURE

FINISHES / FINITIONS /
ACABADOS

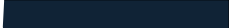
		●	PIANI IN FENIX - BORDO UNICOLOR FENIX TOPS - UNICOLOR EDGE / PLAN DE TRAVAIL FENIX - CHANT UNICOLOR / ENCIMERAS FENIX - BORDE UNICOLOR
		● ●	PIANI IN HPL STRATIFICATO HPL STRATIFIED TOPS / PLAN DE TRAVAIL HPL STRATIFIÉS / ENCIMERAS HPL ESTRATIFICADAS
	1,2 cm	●	PIANI IN QUARZO DEKTON® QUARTZ DEKTON® WORKTOPS / PLAN DE TRAVAIL QUARTZ DEKTON® / ENCIMERAS DE CUARZO DEKTON®
	1,2 cm	●	PIANI IN MDI INALCO INALCO MDI TOPS / PLAN DE TRAVAIL INALCO MDI / INALCO MDI TOPS
		●	PIANI IN LAMINAM LAMINAM TOPS / PLAN DE TRAVAIL LAMINAM / ENCIMERA DE LAMINAM
		●	PIANI IN VETRO TEMPERATO TEMPERED GLASS TOPS / PLAN DE TRAVAIL EN VERRE TEMPÉRÉ / ENCIMERA DE CRISTAL TEMPLADO
	1,5 ÷ 5 cm		PIANI IN ACCIAIO "BARAZZA" "BARAZZA" STAINLESS STEEL TOPS / PLAN DE TRAVAIL EN ACIER "BARAZZA" / ENCIMERA DE ACERO "BARAZZA"
		●	PIANI IN LAMINATO - BORDO ABS LAMINATE TOPS - ABS EDGE / PLAN DE TRAVAIL STRATIFIÉ - CHANT EN ABS / ENCIMERA DE LAMINADO - CANTO DE ABS
	2 cm	● ●	PIANI IN LAMINATO HPL - LAMICOLOR / BORDO UNICOLOR HPL LAMINATE TOPS - LAMICOLOR/UNICOLOR EDGE / PLAN DE TRAVAIL STRATIFIÉ HPL - CHANT LAMICOLOR/UNICOLOR / ENCIMERA LAMINADOS HPL - LAMICOLOR/BORDE UNICOLOR
	2 cm	● ●	PIANI IN UNICOLOR UNICOLOR TOPS / PLAN DE TRAVAIL UNICOLOR / ENCIMERA DE UNICOLOR
		● ●	PIANI IN FENIX - BORDO UNICOLOR FENIX TOPS - UNICOLOR EDGE / PLAN DE TRAVAIL FENIX - CHANT UNICOLOR / ENCIMERA FENIX - CANTO UNICOLOR
		●	PIANI IN MARMO/GRANITO MARBLE/GRANITE TOPS / PLAN DE TRAVAIL MARBRE/GRANIT/ ENCIMERAS DE MÁRMOL/GRANITO
		●	PIANI IN QUARZO SILESTONE® QUARTZ SILESTONE® TOPS / PLAN DE TRAVAIL EN QUARTZ SILESTONE® / ENCIMERAS DE CUARZO SILESTONE®
	3 cm		PIANI IN MARMO/GRANITO MARBLE/GRANITE TOPS / PLAN DE TRAVAIL EN MARBRE/GRANIT / ENCIMERAS DE MÁRMOL/GRANITO
			PIANI IN QUARZO SILESTONE® QUARTZ SILESTONE® COUNTERTOPS / PLAN DE TRAVAIL EN QUARTZ ET SILESTONE® / ENCIMERAS DE CUARZO SILESTONE®
		●	PIANI IN LAMINATO - BORDO ABS LAMINATE TOPS - ABS EDGE / PLAN DE TRAVAIL STRATIFIÉS - CHANT EN ABS / ENCIMERA DE LAMINADO - CANTO DE ABS
	4 cm	● ●	PIANI IN LAMINATO HPL - LAMICOLOR / BORDO UNICOLOR HPL LAMINATE TOPS - LAMICOLOR/UNICOLOR EDGE / PLAN DE TRAVAIL STRATIFIÉS HPL - CHANT LAMICOLOR/CHANT UNICOLOR / ENCIMERA LAMINADOS HPL - LAMICOLOR / BORDE UNICOLOR
	4 cm	● ●	PIANI IN UNICOLOR UNICOLOR TOPS / PLAN DE TRAVAIL UNICOLOR / ENCIMERA DE UNICOLOR
		● ●	PIANI IN FENIX - BORDO UNICOLOR FENIX TOPS - UNICOLOR EDGE / PLAN DE TRAVAIL FENIX - CHANT UNICOLOR / ENCIMERA FENIX - CANTO UNICOLOR
		●	PIANI IMPIALLACCIATI VENEERED TOPS / PLAN DE TRAVAIL PLACAGE BOIS / ENCIMERA EN CHAPA DE MADERA
	6 cm		PIANI IMPIALLACCIATI VENEERED TOPS / PLAN DE TRAVAIL PLACAGE BOIS / ENCIMERA EN CHAPA DE MADERA