

# PIXIE

by Miniforms Lab



Pixie è il bambino dentro ognuno di noi. Un invito a continuare a sognare, a sedersi intorno a un tavolo per pranzare, scherzare e lavorare.

Pixie is the child inside us all. It's an invitation to continue daydreaming, to sit around a table and enjoy lunch, joke around and work.

## DIMENSIONI | DIMENSIONS



\*lunghezza | width: 130 cm  
larghezza | depth: 130 cm  
altezza | height: 75 / 75,6 / 76,2 cm

\*\*lunghezza | width: 150 cm  
larghezza | depth: 150 cm  
altezza | height: 75 / 75,6 / 76,2 cm

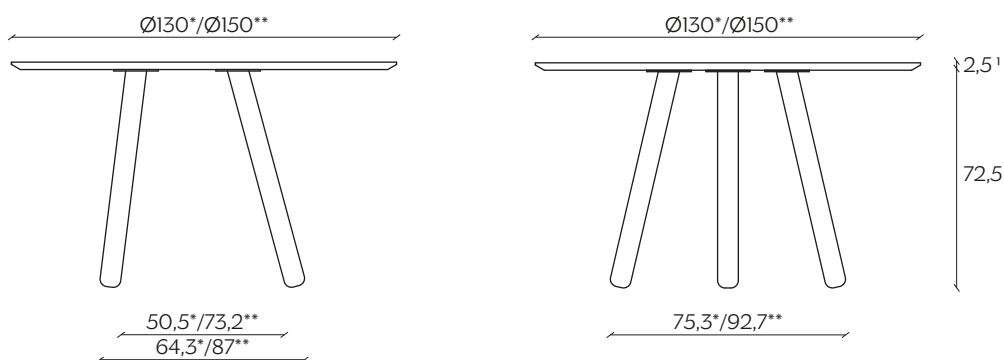

## AMBIENTE | ENVIRONMENT

interno | indoor

## DOWNLOAD | DOWNLOADS

la guida Cura e Manutenzione è disponibile su [miniforms.com](http://miniforms.com)  
Care and Maintenance guide is available at [miniforms.com](http://miniforms.com)

file 2D, 3D e fotografie sono disponibili su [miniforms.com](http://miniforms.com)  
2D, 3D files and hi-res images are available at [miniforms.com](http://miniforms.com)

<sup>1</sup> spessore per piani in legno; piano in ceramica 3,1 cm, piano in marmo Palladio Moro 3,7 cm  
thickness for wooden tops; ceramic tops 3,1 cm, Palladio Moro marble top 3,7 cm

# FINITURE | FINISHES

## PIANO | TOP

### Legno | Wood



Rovere Fiammato  
Flamed Oak



Rovere Vintage  
Vintage Oak

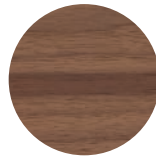

Noce Canaletto  
Canaletto Walnut



Frassino Nero  
Black Ash

### Gres Porcellanato | Porcelain Stoneware

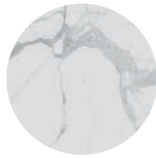

Statuario Bianco

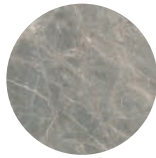

Étoil Gris

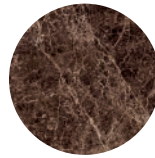

Emperador

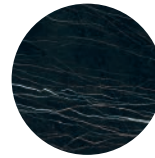

Thundernight

### Marmo | Marble

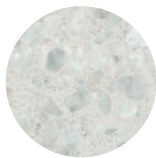

Palladio Doge

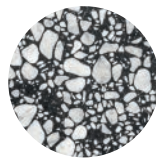

Palladio Moro

### Laccato | Lacquer

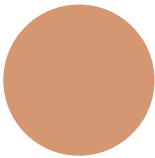

Albicocca  
NCS: S2030-Y40R

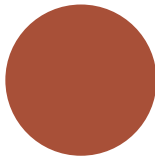

Pompei  
NCS 4550-Y70R

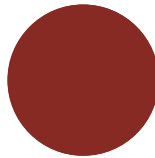

Bloody Mary  
NCS 4550-Y80R

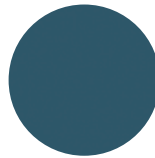

Bisanzio  
NCS 6030-B

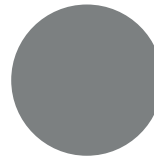

Crigio Polvere  
RAL: 7037

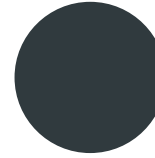

Antracite  
RAL: 7016

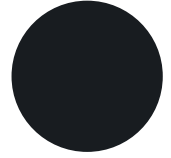

Nero  
RAL: 9005



Bianco  
RAL: 9016



Canapa  
NCS: 1502-Y



Crigio Seta  
RAL: 7044



New Juta  
NCS: 3010-Y30R

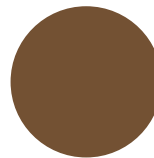

Visone  
NCS: 6010-Y60R

## FINITURE | FINISHES

### Cambe | Legs

#### Legno | Wood



Frassino  
Ash

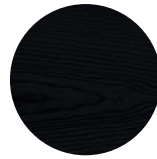

Frassino Nero  
Black Ash

#### Metallo | Metal

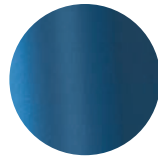

Laccato (12 colori)  
Lacquered (12 tones)

# PIXIE

by Miniforms Lab

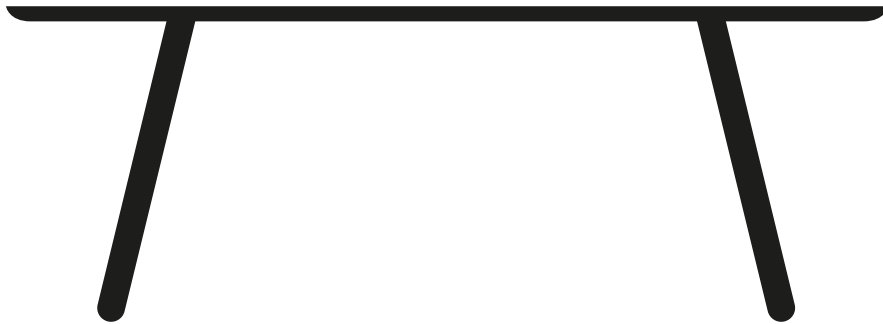

Pixie è il bambino dentro ognuno di noi. Un invito a continuare a sognare, a sedersi intorno a un tavolo per pranzare, scherzare e lavorare.

Pixie is the child inside us all. It's an invitation to continue daydreaming, to sit around a table and enjoy lunch, joke around and work.

## DIMENSIONI | DIMENSIONS



\*lunghezza | width: 200 cm  
 larghezza | depth: 100 cm  
 altezza | height: 75 / 75,6 / 76,2 cm

\*\*lunghezza | width: 240 cm  
 larghezza | depth: 100 cm  
 altezza | height: 75 / 75,6 / 76,2 cm

\*\*\*lunghezza | width: 300 cm  
 larghezza | depth: 100 cm  
 altezza | height: 75 / 75,6 / 76,2 cm

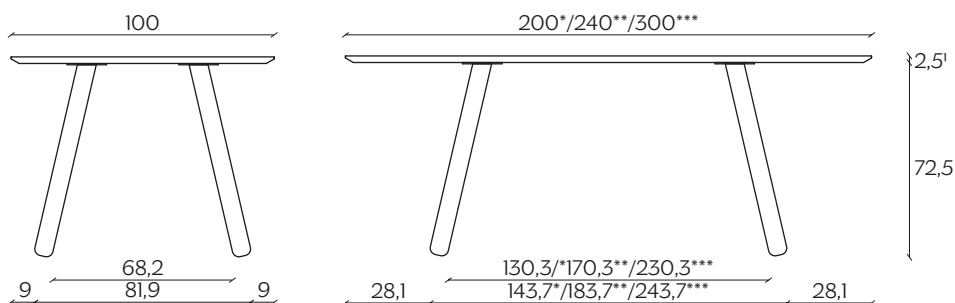

\*lunghezza | width: 200 cm  
 larghezza | depth: 100 cm  
 altezza | height: 75 / 75,6 / 76,2 cm

\*\*lunghezza | width: 240 cm  
 larghezza | depth: 100 cm  
 altezza | height: 75 / 75,6 / 76,2 cm

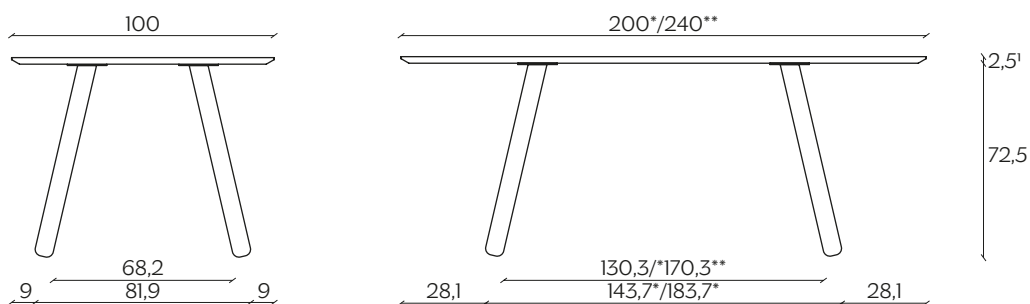

<sup>1</sup> spessore per piani in legno; piano in ceramica 3,1 cm, piano in marmo Palladio Moro 3,7 cm  
 thickness for wooden tops; ceramic tops 3,1 cm, Palladio Moro marble top 3,7 cm

## AMBIENTE | ENVIRONMENT

interno | indoor

## DOWNLOAD | DOWNLOADS

la guida Cura e Manutenzione è disponibile su [miniforms.com](https://miniforms.com)  
Care and Maintenance guide is available at [miniforms.com](https://miniforms.com)

file 2D, 3D e fotografie sono disponibili su [miniforms.com](https://miniforms.com)  
2D, 3D files and hi-res images are available at [miniforms.com](https://miniforms.com)

# FINITURE | FINISHES

## PIANO | TOP

### Legno | Wood



Rovere Fiammato  
Flamed Oak



Rovere Vintage  
Vintage Oak

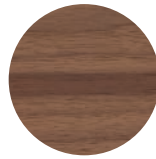

Noce Canaletto  
Canaletto Walnut



Frassino Nero  
Black Ash

### Gres Porcellanato | Porcelain Stoneware

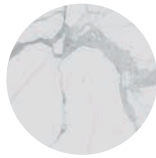

Statuario Bianco

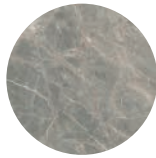

Étoil Gris

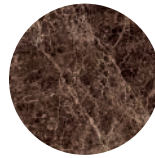

Emperador

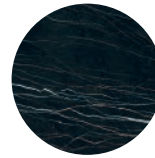

Thundernight

### Marmo | Marble



Palladio Doge

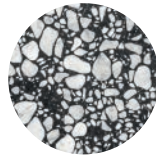

Palladio Moro

### Laccato | Lacquer

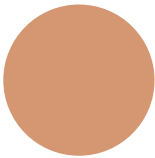

Albicocca  
NCS: S2030-Y40R

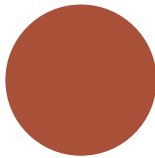

Pompei  
NCS 4550-Y70R

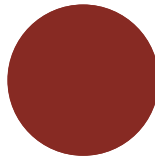

Bloody Mary  
NCS 4550-Y80R

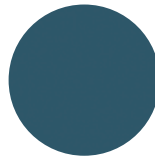

Bisanzio  
NCS 6030-B

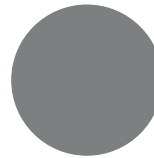

Crigio Polvere  
RAL: 7037

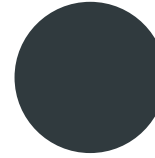

Antracite  
RAL: 7016

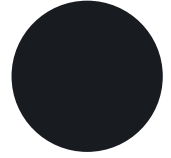

Nero  
RAL: 9005



Bianco  
RAL: 9016



Canapa  
NCS: 1502-Y



Crigio Seta  
RAL: 7044

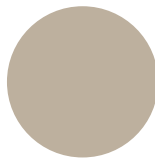

New Juta  
NCS: 3010-Y30R

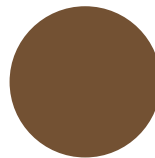

Visone  
NCS: 6010-Y60R



## FINITURE | FINISHES

### Cambe | Legs

#### Legno | Wood



Frassino  
Ash



Frassino Nero  
Black Ash

#### Metallo | Metal

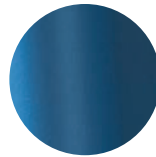

Laccato (12 colori)  
Lacquered (12 tones)