

EITIE Line
TOBIA SCARPA, 2023



EN A family of eye-catching lamps, inspired by a wall installation designed by Tobia Scarpa, that emerges from a seemingly simple structure and sophisticated, innovative technology. The concept for EITIE, a palindrome in honour of Scarpa's age, elaborates upon the idea of a luminous line that, thanks to unique circular connectors, expresses itself in various configurations. Each element is composed of two or three luminous lines that can be joined to form various compositions, thanks to circular black metal connectors, embellished with silver details, that contain cutting-edge technology hidden in their interior.

IT Una famiglia di lampade scenografiche, nata dallo sviluppo di un'installazione a parete firmata da Tobia Scarpa, che prende vita attraverso una struttura apparentemente semplice e una tecnologia sofisticata e innovativa. Il concept di Eitie, palindromo che omaggia l'età di Scarpa, elabora l'idea di una linea luminosa declinata in varie configurazioni attraverso caratteristiche connessioni circolari. Ogni elemento è composto da due o tre linee luminose che possono essere collegate in varie composizioni grazie alle connessioni metalliche nere di forma circolare, arricchite con dettagli in argento, che all'interno nascondono una tecnologia all'avanguardia.

FR Une famille de lampes à effet scénographique, née du développement d'une installation murale signée Tobia Scarpa, qui prend vie grâce à une structure apparemment simple et à une technologie sophistiquée et innovante. Le concept d'EITIE, palindrome rendant hommage à l'âge de Scarpa, développe l'idée d'une ligne lumineuse déclinée en différentes configurations à travers des connexions circulaires caractéristiques. Chaque élément est composé de deux ou trois lignes lumineuses qui peuvent être combinées dans différentes compositions grâce aux connexions en métal noir de forme circulaire, agrémentées de détails en argent, qui recèlent une technologie de pointe.

DE Diese Familie mit szenografischen Leuchten ist eine Weiterentwicklung der Wandinstallation von Tobia Scarpa, die mit einer auf den ersten Blick schlichten Konstruktion und einer modernen und innovativen Technologie zum Leben erweckt wird. Das Konzept von EITIE, ein Palindrom, das eine Hommage an das Alter von Scarpa ist, setzt die Idee einer Lichtlinie um, die durch die charakteristischen runden Verbindungen verschiedene Konfigurationen annimmt. Jede Leuchte besteht aus zwei oder drei Lichtlinien, die dank der schwarzen runden Verbindungselemente aus Metall mit Details in Silber und einer hochmodernen Technologie in ihrem Inneren in verschiedenen Kompositionen angeordnet werden können.

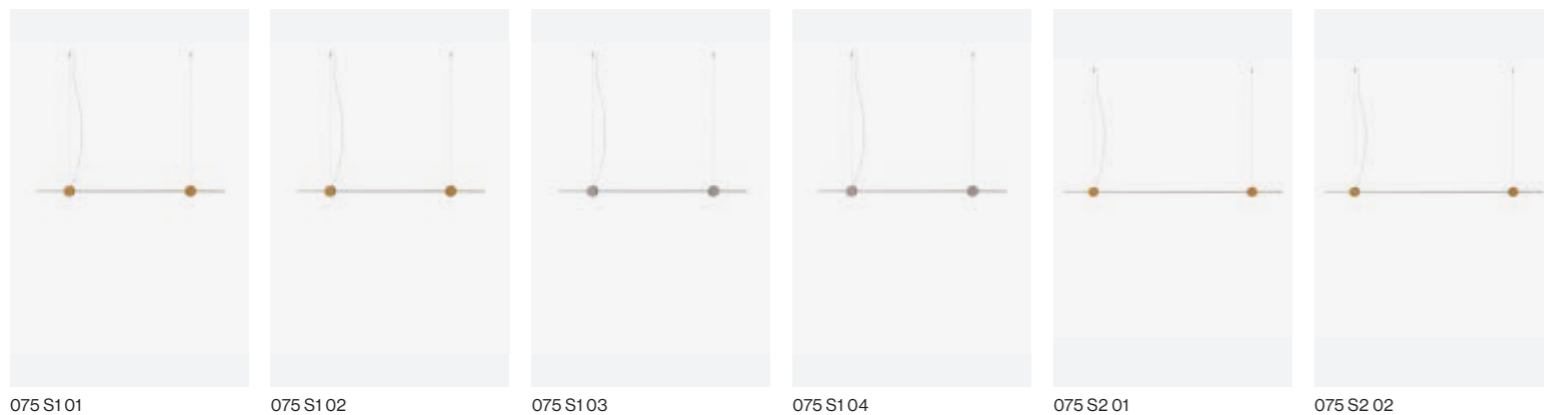

075 S1 01

075 S1 02

075 S1 03

075 S1 04

075 S2 01

075 S2 02

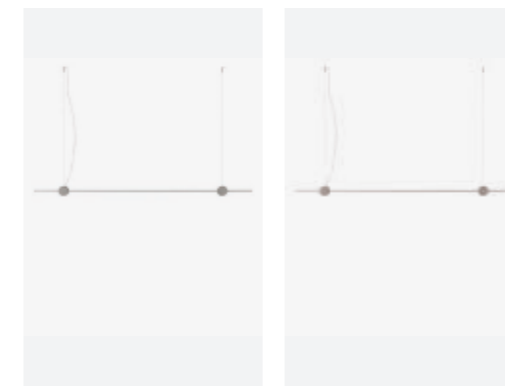

075 S2 03

075 S2 04

Pendant lamp

Lampada a sospensione
Suspension luminaire
Pendelleuchte

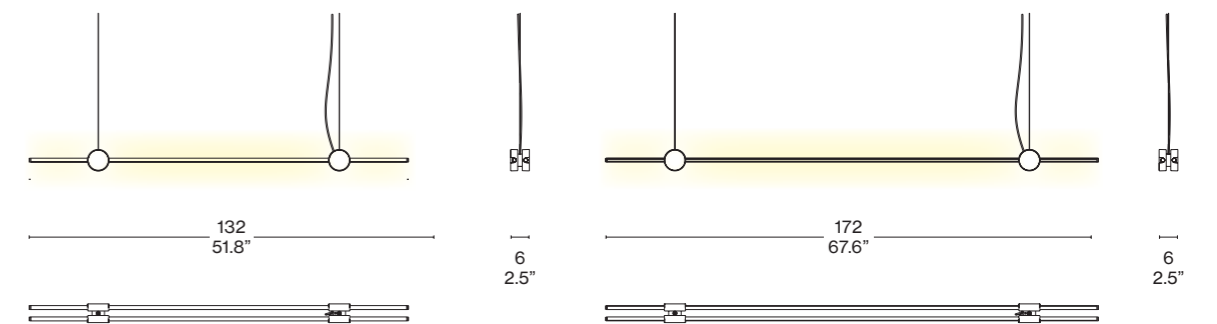

Joins

Giunti
Articulations
Gelenke

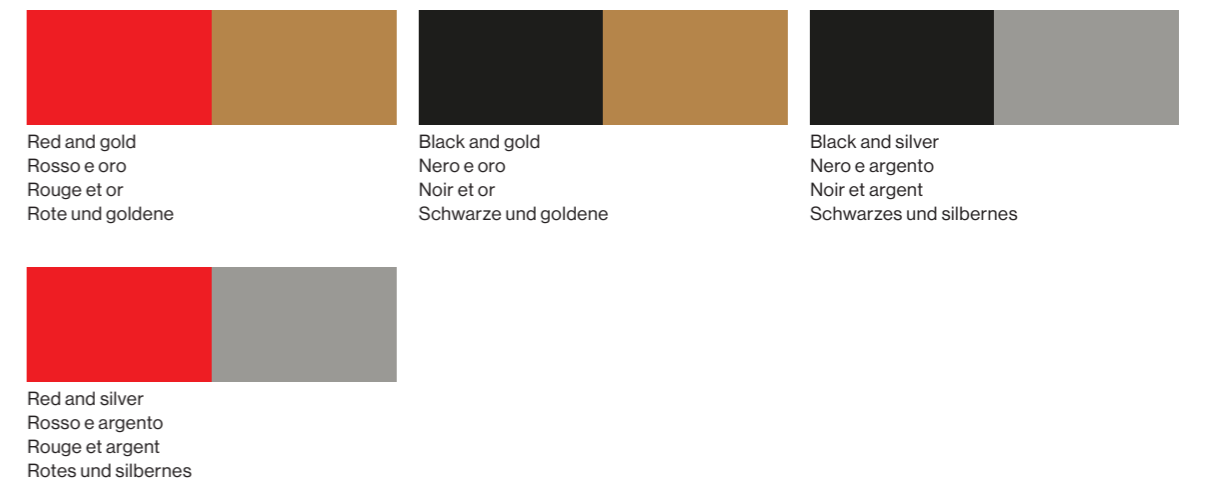

Red and gold
Rosso e oro
Rouge et or
Rote und goldene

Black and gold
Nero e oro
Noir et or
Schwarze und goldene

Black and silver
Nero e argento
Noir et argent
Schwarzes und silbernes

Red and silver
Rosso e argento
Rouge et argent
Rotes und silbernes

075 S1

075 S2

Technical Informations

Caratteristiche tecniche
Caractéristiques techniques
Technische Merkmale

Material

Materiale
Materiaux
Gestell

Aluminium, steel, PMMA, PA66
Alluminio, acciaio, PMMA, PA66
Aluminium, acier, PMMA, PA66
Aluminium, Stahl, PMMA, PA66

Aluminium, steel, PMMA, PA66
Alluminio, acciaio, PMMA, PA66
Aluminium, acier, PMMA, PA66
Aluminium, Stahl, PMMA, PA66

Light source

Fonte luminosa
Source lumineuse
Lichtquelle

LED module (included)
Modulo LED (incluso)
Module LED (inclus)
LED-Modul (enthalten)

LED module (included)
Modulo LED (incluso)
Module LED (inclus)
LED-Modul (enthalten)

Light source replaceability

Sostituibilità della fonte luminosa
Remplacement de la source lumineuse
Austauschbarkeit der Lichtquelle

Non-replaceable built-in LED
LED integrato non sostituibile
LED intégrée, non remplaçable
Integrierte, nicht austauschbare LED

Non-replaceable built-in LED
LED integrato non sostituibile
LED intégrée, non remplaçable
Integrierte, nicht austauschbare LED



Regulation

Regolazione
Régulation
Regulierung

Remotely adjustable (dimmer not included)
Regolabile da remoto (dimmer non incluso)
Réglable à distance (variateur non inclus)

Remotely adjustable (dimmer not included)
Regolabile da remoto (dimmer non incluso)
Réglable à distance (variateur non inclus)
Ferngesteuert einstellbar (Dimmer nicht enthalten)

Suspension Lamps

| | 075 S1 | 075 S2 |
|--|--|--|
| Voltage Voltaggio Tension Spannung | 100-240 V | 100-240 V |
| Power Potenza Puissance Leistung | 25 W | 34 W |
| Temperature Temperatura Température Temperatur | 2700 K | 2700 K |
| System flow Flusso sistema Flux du système Systemfluss | 3960 lm | 5280 lm |
| Cri Cri Cri Cri | 95 | 95 |
| Power supply Alimentatore Alimentation Stromzufuhr | Direct light, indirect light Luce diretta, luce indiretta Lumière directe, lumière indirecte Direktes licht, indirektes licht | Direct light, indirect light Luce diretta, luce indiretta Lumière directe, lumière indirecte Direktes licht, indirektes licht |
| Cable length Lunghezza cavo Longueur du câble Kabellänge | 270 cm | 270 cm |
| Cable colour and material Colore e materiale cavo Couleur et matériau du câble Farbe und Material des Kabels | Transparent Transparente Transparent Transparent | Transparent Transparente Transparent Transparent |
| Type of ceiling connection Tipo di attacco a soffitto Type de fixation au plafond Deckenanschlussty | Rosette Rosone Rosace Rosette | Rosette Rosone Rosace Rosette |
| Net weight Peso netto Poids net Netto Gewicht | 0,5 kg | 0,6 kg |
| Certifications Certificazioni Certifications Zertifizierungen |  |  |

Eitie Collection

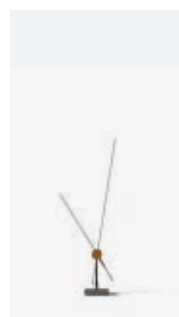

Table, p. 52



Floor, p. 70



Suspension, p. 100



Suspension, p. 104



Wall, p. 142

