

## EXTRASOFT CONTENITORI

design Piero Lissoni

Family of modular storage units, available in two heights with open compartments of different sizes and capacities, to be combined with Extrasoft upholstered elements or usable as freestanding low tables. Made of MDF veneered in natural oak, tobacco-dyed oak or charcoal-dyed oak, with 12 mm thick tops and bases and 40 mm thick side panels. Floor support provided by adjustable plastic feet. The various elements are joined together by means of hooks.

### Structure

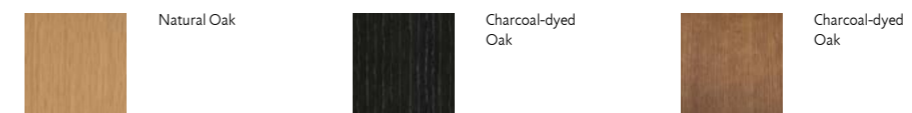

### Notes

The various elements are joined together by means of hooks to be placed in the appropriate milling, as per the instructions enclosed with the product.

In case of using spacers for upholstered elements, it is necessary to use the foot with height 7 cm (2).

Hooks for assembly with upholstered elements with standard feet.

Hooks for assembly with upholstered elements with feet with spacers.

1. Foot Extrasoft Contenitore standard height  
2. Foot Extrasoft Contenitore height 7 cm.

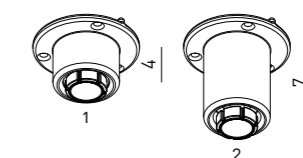
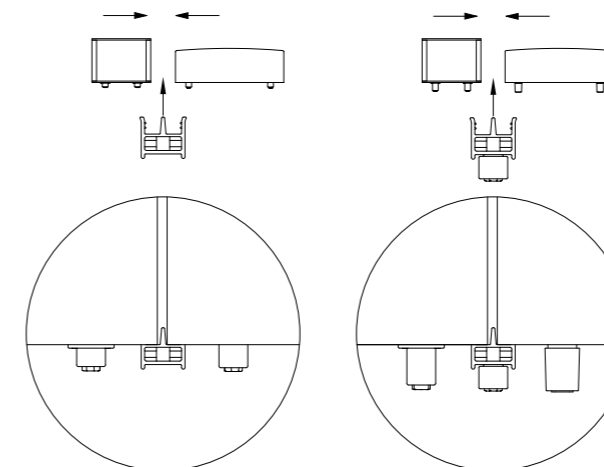

Wood is a living material; therefore, it can have slight color and dimension changes. The presence of any non-homogeneous color shades is not to be considered a defect but a quality. Please note that the direct sunlight exposure may alter the wood color; therefore, we recommend the periodic position shift of the objects placed on the furniture for the first months to avoid differences in shades between exposed and covered portions.

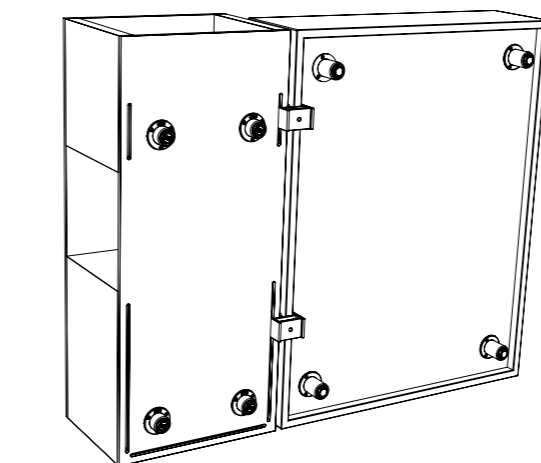

For composition with different elements, please attach a general sketch to the order.

### Technical Drawings

Storage unit cm.94x51 h.43-33

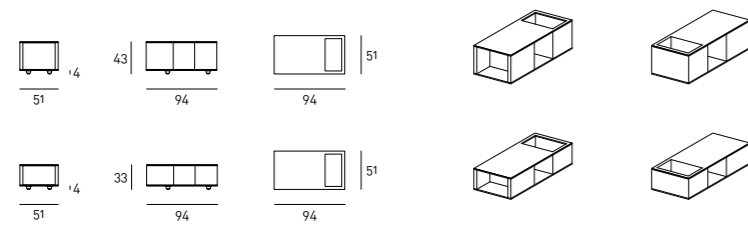

Storage unit cm.120x51 h.43-33

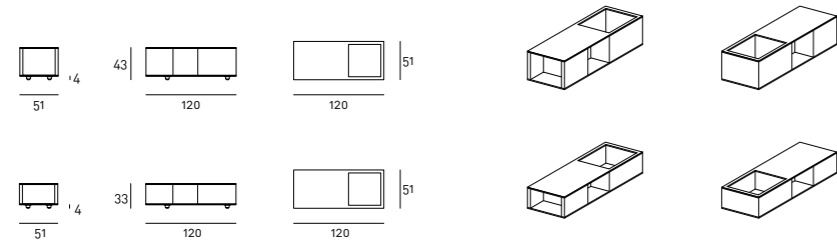

Storage unit cm.146x51 h.43-33

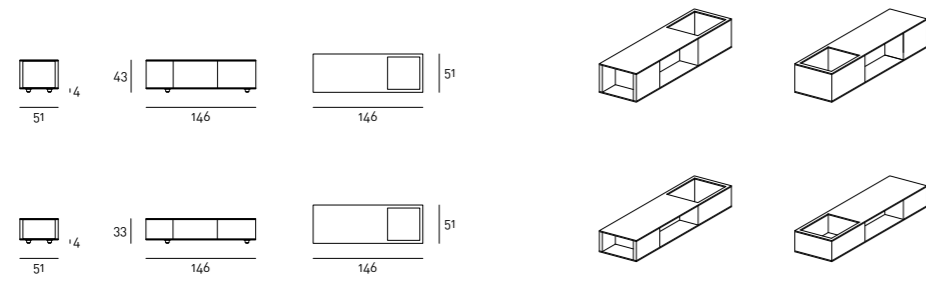

### Examples of Composition

Composition 01

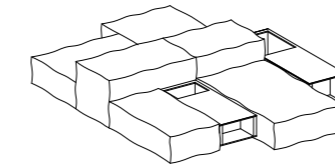
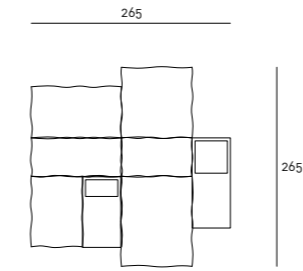

ESOE968  
ESOE994  
ESOE068  
ESOE094

ESOB094A  
ESOB120A  
ESOV094B  
ESOV120A

Composition 02

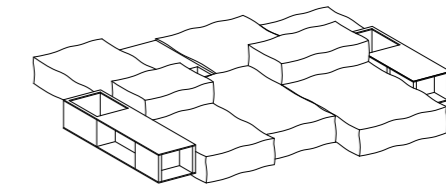
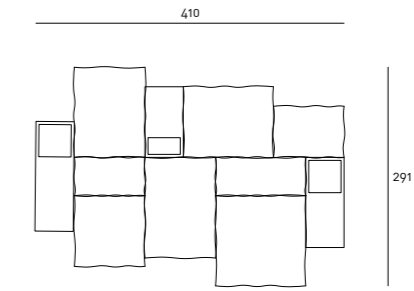

ESOE968  
ESOE994  
ESOE094  
ESOE120

ESOE134  
ESOB094A  
ESOB120A  
ESOV120A  
ESOV146A

Composition 03

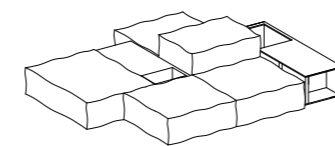

ESOE968  
ESOE994  
ESOB094A

ESOV094B  
ESOV120A

Composition 04

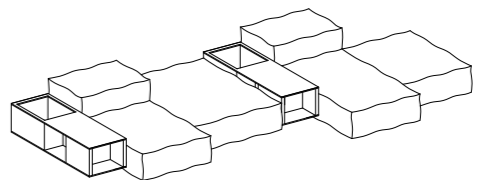

ESOE994  
ESOE094  
ESOE120

ESOB094A  
ESOV120A  
ESOV146A

Examples of Composition  
Composition 05

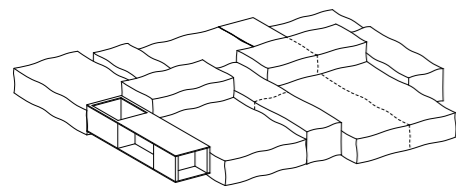
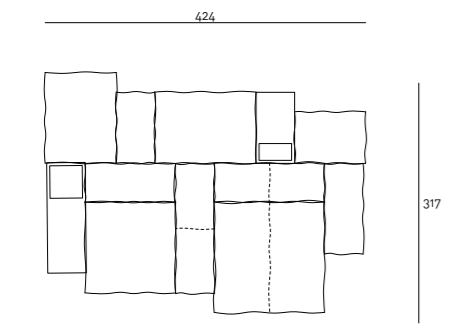

ESOE968	ESOB120B
ESOE094	ESOB172B
ESOE120	ESOB120A
ESOE134	ESOB146A
ESOE146	ESOV094B
ESOB094B	ESOV146A

Composition 06

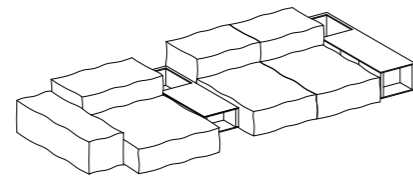
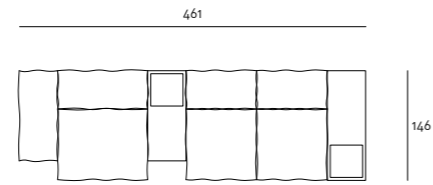

ESOE994	ESOB120A
ESOE094	ESOV120B
ESOB120B	ESOV146B
ESOB094A	



The commercial codes refer to the elements chosen in the above-proposed compositions