

C.O.P. Storage Units

Design:

MIKAL HARRSEN
CREATIVE OFFICE PROJECT
2012

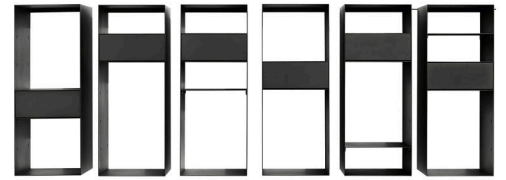

+ info: <https://www.depadova.com/materials.pdf>
De Padova srl - info@depadova.it

STORAGE SYSTEM.

Materials

Storage units, shelves, drawers and wall bracket
steel sheet with welded and polished corners, embossed black or white
powder-coated. Magnetic fastening of additional shelves. Drawers are fitted
with magnetic handle.

Concealed rail
aluminium profile.

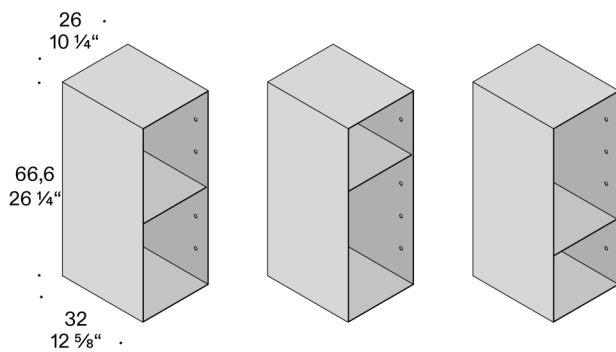

C.O.P. Storage Units

Design:

MIKAL HARRSEN
CREATIVE OFFICE PROJECT
2012

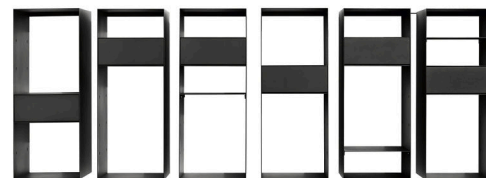

+ info: <https://www.depadova.com/materials.pdf>

De Padova srl - info@depadova.it

SISTEMA DI CONTENIMENTO.

Materiali

Contenitori, ripiani, cassetti, e staffa a parete
lamiera di acciaio con spigoli saldati e levigati, verniciata a polvere color nero
o bianco goffrato. Fissaggi magnetici dei ripiani aggiuntivi. I cassetti sono
dotati di maniglia magnetica.

Binario nascosto
profilo in alluminio.

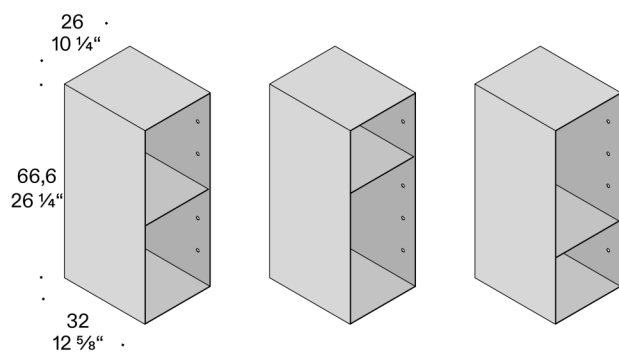

C.O.P. Storage Units

Design:

MIKAL HARRSEN
CREATIVE OFFICE PROJECT
2012

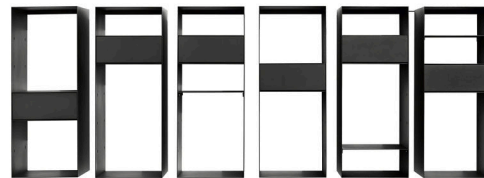

+ info: <https://www.depadova.com/materials.pdf>

De Padova srl - info@depadova.it

SYSTÈME DE RANGEMENT.

Matériaux

Éléments de rangement, étagères, tiroirs, et étrier mural
tôle d'acier avec arêtes soudées et polies, peinte à poudre couleur noir ou
blanc gaufré. Fixations magnétiques des étagères supplémentaires. Les
tiroirs sont munis de poignée magnétique.

Rail caché
profilé en aluminium.

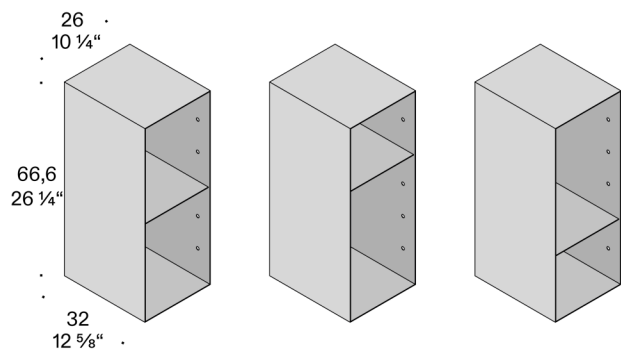

C.O.P. Storage Units

Design:

MIKAL HARRSEN
CREATIVE OFFICE PROJECT
2012

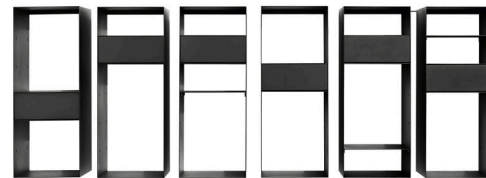

+ info: <https://www.depadova.com/materials.pdf>

De Padova srl - info@depadova.it

AUFBEWAHRUNGSSYSTEM.

Materialien

Schrankelemente, Regalböden, Schubladen und Wandhalterungen
Stahlblech mit geschweißten und geschliffenen Kanten, schwarz oder weiß
gaufriert pulverlackiert. Magnetische Befestigung für zusätzliche
Einlegeböden. Die Schubladen sind mit einem magnetischen Griff
ausgestattet.

Verdeckte Schiene
Aluminiumprofil.

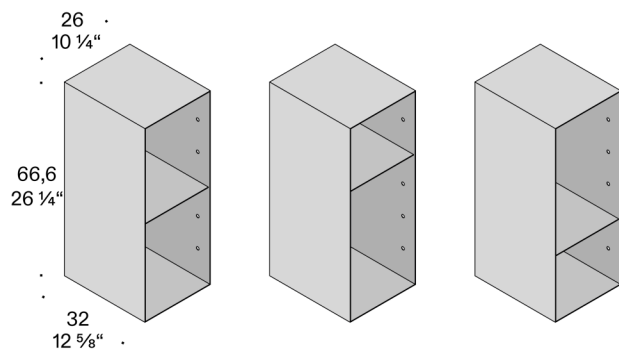

C.O.P. Storage Units

Design:

MIKAL HARRSEN
CREATIVE OFFICE PROJECT
2012

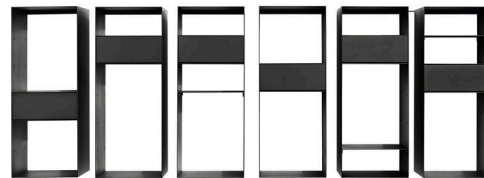

+ info: <https://www.depadova.com/materials.pdf>

De Padova srl - info@depadova.it

SISTEMA DE CONTENCIÓN.

Materiales

Muebles contenedores, baldas, cajones y escuadra de pared
chapa de acero con cantos soldados y pulidos, pintada con polvo color negro
o blanco gofrado. Fijaciones magnéticas de los estantes adicionales. Los
cajones están equipados con tirador magnético.

Guía oculta

perfil de aluminio.

