

GLISS MASTER — VINCENT VAN DUYSSEN 2015

1—
49



The Gliss Master wardrobe system has been enriched with a new type of door featuring an ingenious opening mechanism: Sistema 7. The core of the design is a patented, horizontally folding mechanism that enables the doors to be moved effortlessly and silently from their initial housing at the side of the compartment, thereby making it fully accessible. The doors thus opened and folded back, are aligned parallel to the adjacent compartment, without occupying space in front of it. Sistema 7 is designed to accommodate very thick doors, lacquered, in wood or glass with patterned acid etching on the front. Sistema 7 is particularly suitable for corner solutions or as an opening in walk-in wardrobes, acting as a partition between the spaces in front of or in a wardrobe placed in the centre of a room or as access to a different room.

FINISHES

Finishes components

		melamine structure	piqué melamine (XQ)	melamine front	matt lacquer colours	cartapaglia lacquered	glossy lacquer colours	woods	coloured glass/etched coloured glass/mirror	shiny aluminium/black chrome	pewter colour/bronze	Eco Skin	extraclear transparent glass/franparent stopsol/stopsol	fine grain	net glass	
linear module and corner module	base/lid															
	back panel													only linear		only linear
wooden central partition																
wooden external side panel																
extension profile																
central partition or side panel frame or glass	frame															
	glass													central only transparent		only side panel
START / TWIN door																
"A FILO" door																
"A FILO" glass door	profile															
	glass															
BLADE sliding door																
GRIP door																
DEEP door																
NICHE door									only vertical							
GLASS door	profile															
	glass															
SISTEMA 7 wood																
SISTEMA 7 glass	profile															
	glass															
SWING door																
WINDOW door	profile															
	glass															
SKIN door	profile															
	panel															

internal fittings

		melamine structure	piqué melamine (XQ)	melamine structure	Eco Skin	fine grain	transparent glass	pewter colour/bronze	grey saffiano melamine	larix dark/ silver cembran	matt lacquer colours
shelf											
wooden drawer fronts H 126/190/382											
tray front (trouser holders/trinket trays)											
front for open drawers / pull-out trays											
glass drawer fronts/ glass shelf	profile										
	glass										
drawer internal											
dividing partitions - grid with shirt/sweater holders											
island drawer unit											
drawer unit											

colours

<p>Melamine structure YB white shantung YG grey shantung YM larix dark YA silver cembran WW white</p> <p>Melamine front KA cartapaglia anthracite KB cartapaglia white KS cartapaglia silica WS graffiato silica WB graffiato bronze ZB silk chalk white ZS silk silica ZT silk dove grey</p>	<p>Matt lacquer/ Cartapaglia lacquered BC chalk white PE pearl DN dune PL platinum NE black AT anthracite SE mustard SI silica DO dolomite grey AL clay MK moka CM caramel CZ light blue grey SA sand RU ruby RE rust PX pewter colour RX copper TO dove grey</p>	<p>Glossy lacquer BC chalk white PE pearl DN dune PL platinum NE black AT anthracite SE mustard SI silica DO dolomite grey AL clay MK moka CM caramel CZ light blue grey SA sand RU ruby RE rust PX pewter colour RX copper TO dove grey</p>	<p>Coloured glass BC chalk white PE pearl DN dune PL platinum NE black AT anthracite SE mustard SI silica DO dolomite grey AL clay MK moka CM caramel CZ light blue grey SA sand RU ruby RE rust PX pewter colour RX copper TO dove grey</p>	<p>Etched coloured glass BC chalk white PE pearl DN dune PL platinum NE black AT anthracite SE mustard SI silica DO dolomite grey AL clay MK moka CM caramel CZ light blue grey SA sand RU ruby RE rust PX pewter colour RX copper TO dove grey</p>	<p>Woods EU eucalyptus RG grey oak RF graphite oak</p>	<p>Eco Skin grey mink hemp ivory dark brown</p>
---	--	---	---	--	---	--

TECHNICAL INFORMATION

STRUCTURE

BASE

Wooden particleboard panel faced with melamine and adjustable feet in contact with the ground.

COVER, PARTITION AND BACK PANEL

Wooden particleboard panel faced with melamine. The partitions are provided with adjustable feet in contact with the ground.

FINE GRAIN BACK PANEL

Chipboard coated with cylinder etched coextruded sheet of ABS-PMMA, painted in specific Molteni finish.

BACK PANEL, LID, SIDE PANEL AND CENTRAL PARTITION (GLASS)

Frame perimeter in painted extruded aluminium with 4 mm tempered glass. Available in different finishes.

SIDE PANEL (MELAMINE)

Wooden particleboard panel faced with melamine. Adjustable feet in contact with the ground.

SIDE PANEL (MATT OR GLOSSY LACQUERED IN THE COLOURS)

Wooden particleboard panel faced with melamine. Outside painted in the colours of the "Molteni Range". Adjustable feet in contact with the ground.

SIDE PANEL (WOOD)

Wooden particleboard panel with inner melamine facing and outer facing with sliced Oak (Quercus) or Eucalyptus (Eucalyptus globulus). Adjustable feet in contact with the ground.

CENTRAL FRAME PARTITION

Frame perimeter in painted extruded aluminium.

COVERING PROFILES AND RUNNERS

Extruded aluminium covered with melamine facing or painted, with dust-proof seals.

FRONT EDGING

Anodised extruded aluminium, lacquered in the "Molteni Range" colours or faced with sliced Oak or Eucalyptus.

DOORS

MELAMINE (START - TWIN - "A FILO" - BLADE - GRIP - DEEP)

Wooden particleboard panel faced with melamine. Cushioned hinges and sliding system. Handles in various materials and finishes.

MATT OR GLOSSY LACQUERED IN THE COLOURS (START - "A FILO" - BLADE - GRIP - DEEP - NICHE - SWING)

Wooden particleboard panel faced with melamine, painted in the colours of the "Molteni Range". Cushioned hinges and sliding system. Handles in various materials and finishes. For the SWING model, the panel is trimmed using a painted aluminium extrusion.

WOOD (START - TWIN - "A FILO" - BLADE - GRIP - DEEP - NICHE)

Wooden particleboard panel faced with sliced Oak or Eucalyptus. Handles in various materials and finishes.

GLASS HINGED DOOR ("A FILO")

Wooden particleboard panel faced with melamine, with a 5-mm-thick glass panel or mirror applied, painted in the colours of the "Molteni Range". Outer frame profile of anodised extruded aluminium. Cushioned hinges.

GLASS SLIDING DOOR ("A FILO")

Frame in anodised extruded aluminium with mounted mirror or 5 mm glass, painted in "Molteni Range" colours. Sliding system with shock absorbers.

GLASS / SISTEMA 7 glass DOORS

Extruded aluminium frame with 4mm thick glass, available in various finishes. Hinges with 180° opening, for hinged doors. Patented folding mechanism for SISTEMA 7.

WINDOW doors

Frame in painted extruded aluminium with 5 mm glass available in different finishes. Recessed soft close hinges.

SKIN doors

Frame in painted extruded aluminium with honeycomb panel inserted and covered in eco-leather. Recessed soft close hinges.

SISTEMA 7 wood DOORS

Honeycomb panel painted in "Molteni Range" colours or covered with Oak or Eucalyptus wood veneer. Handle in painted extruded aluminium. Hinges with 180° opening for hinged doors. Patented folding mechanism.

TECHNICAL INFORMATION

INTERNAL FITTINGS

PULL-OUT SHIRT HOLDER

Painted parts made using a phenolic laminated panel. Front tray made of woodchip board faced with melamine. Bottom clad in eco-leather

DRAWER UNIT STRUCTURE FOR FRAME SIDES

Chipboard panel with melamine facing, painted in specific Molteni finish.

INNER SHELVES, DRAWER OR TRAY FRONT, MOVABLE TRAYS SET AND GRID WITH SHIRT AND SWEATER HOLDERS

Wooden particleboard panel faced with melamine.

INNER SHELVES WITH FRONT PROFILE

Chipboard panel covered with melamine facing, front profile in painted extruded aluminium.

INNER SHELVES IN ECO SKIN

Chipboard panel covered with melamine facing, front profile in painted extruded aluminium and upper covering in eco-leather.

CLOTHES RODS

Anodised aluminium rod. Tube support of chrome-plated plastic material.

GLASS FRONT PANEL AND GLASS SHELVES

In painted or extruded aluminium. 4-mm-thick tempered glass.

FINE GRAIN FRONT

Chipboard panel covered with cylinder etched coextruded sheet of ABS-PMMA, painted in specific Molteni finish. Perimeter profile in painted extruded aluminium.

DRAWER AND TRAY INNER SIDES

Wooden particleboard panel faced with melamine.

DRAWER AND TRAY INNER BOTTOM

Wooden particleboard panel faced with melamine.

SHOE RACK AND TROUSER RACK PROFILES

In anodised or painted aluminium extrusion.

PULL-OUT MIRROR

Metal frame with mirror 4 mm th.

HANDLES AND VARIOUS ACCESSORIES

In various materials and finishes.

BASE, TOP AND SHELVES IN WOOD (ISLAND WITH GLASS DOORS)

Chipboard panel covered with wood veneer in Eucalyptus or Oak.

IONISER

See technical sheet enclosed with the product.

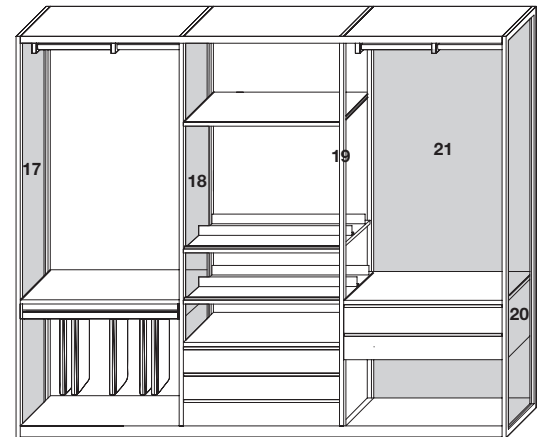
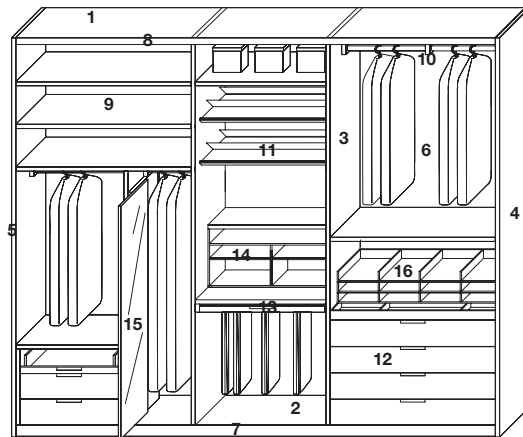

- 1 Top
- 2 Base
- 3 Partition
- 4 Side
- 5 Extension profile
- 6 Back
- 7 Covering profile or bottom runner
- 8 Covering profile or top runner
- 9 Shelf th. 30
- 10 Clothes rails
- 11 Shoe rack shelf
- 12 Drawers
- 13 Trousler holder - trinket trays
- 14 Grid with shirt and sweater holders
- 15 Pull-out mirror
- 16 Pull-out shirt holder

- 17 Side glass panel
- 18 Central glass partition
- 19 Central frame partition
- 20 Drawer unit structure
- 21 Glass back panel

DRAWER INTERIOR

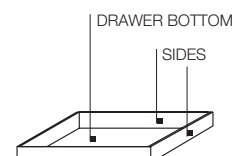

MODULARITY

Modularity - Structure

The widths 492 - 656 - 820 - 984 - 1312 - 464 (term. element) mm (19 3/8" - 25 7/8" -

32 1/4" - 38 3/4" - 51 5/8" - 18 1/4") include the left side panel. The total width of the composition will include the final panel of th. 30 mm (1 1/8").

Heights: tot. H 2343 (92 1/4"), door 2313 (91"), int.2253 (87 3/4"), sliding or flush sl. door inter. 2163 (85 1/8")

tot. H 2439 (96"), door 2409 (94 7/8"), int. 2349 (92 1/2"), sliding or flush sl. door inter. 2259 (88 7/8")

tot. H 2631 (103 5/8"), door 2601 (102 3/8"), int. 2541 (100"), sliding or flush sl. door inter. 2451 (96 1/2")

tot. H 2919 (114 7/8"), door 2889 (113 3/8"), interior 2829 (111 3/8"), only hinged

Assembly instructions

For the assembling of a sliding and a flush sliding door wardrobe a minimum space of 6 cm (2 3/8") is required considering the minimum height of the compartment.

Assembly of the corner element (for wardrobe with doors) requires a minimum extra height of 6 cm (2 3/8").

Assembly of a wardrobe in an alcove requires a minimum extra side space of 4 cm (1 5/8").

A wardrobe with hinged doors and a lighting system requires a minimum extra height of 5 cm (2").

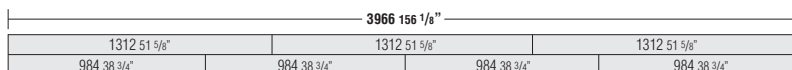
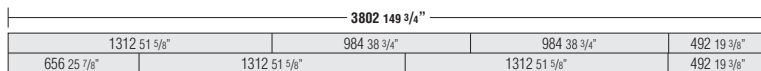
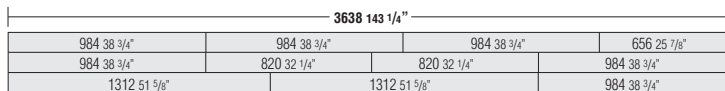
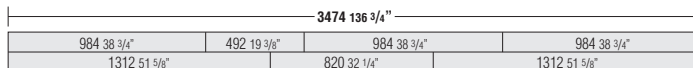
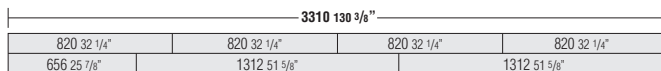
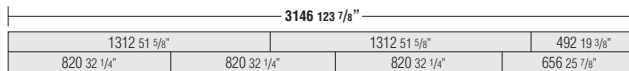
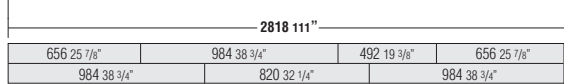
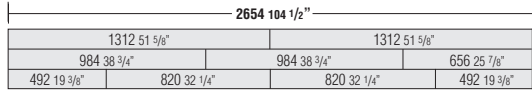
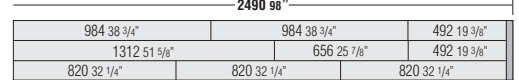
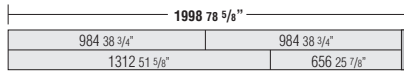
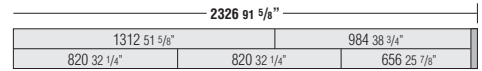
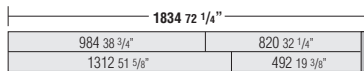
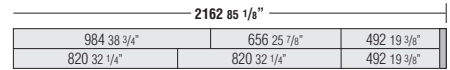
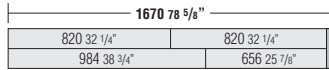
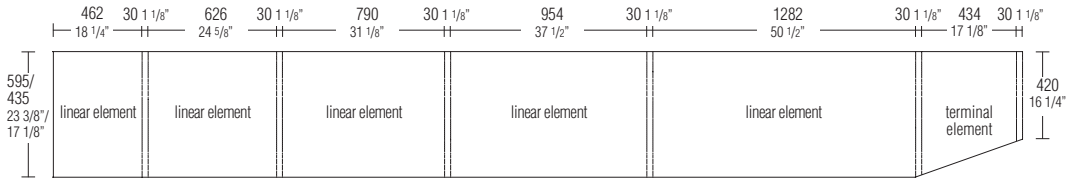

DOORS

START-TWIN hinged doors
applicable only on structures with wood sides

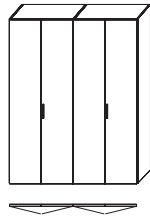

In the pairs of TWIN hinged doors W 815, 979 and 1307, are available 2 handles or handle only on right door.

total height above floor
1190 46 7/8"

The pairs of hinged doors START and "A FILO" always have a handle mounted on the right door.

"A FILO" hinged doors
applicable only on structures with wood sides

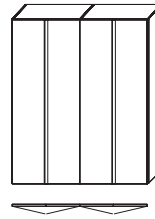

DEEP-GRIP hinged doors
applicable only on structures with wood sides

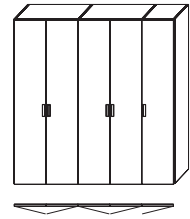

total height above floor
1080 42 1/2"

NICHE doors
applicable only on structures with wood sides

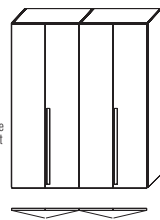

In the pairs of hinged doors W 815, 979 and 1307, are available 2 handles or handle only on right door.

total height above floor
950
37 3/8"

handle height
890
35"

WINDOW - SKIN door
applicable on all types of structures

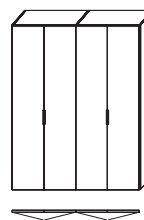

The hinged doors WINDOW and SKIN are made with recessed hinges fixed to base and top, and have a thickness of 30 mm

total height above floor
1080 42 1/2"

GLASS-SWING-SISTEMA 7 doors, th35
applicable on all types of structures

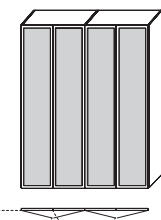

GLASS-SWING doors are made with 180° hinges built into the side (a Molteni exclusive)

180° 180°

Sliding doors

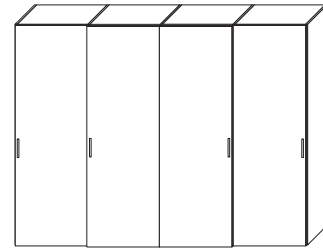
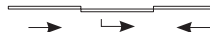
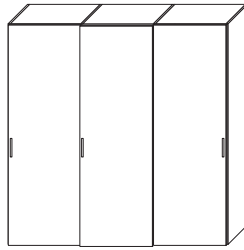
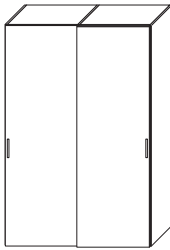

It is possible to make sliding door wardrobes with doors of the following types:

- START
- "A FILO"
- GRIP
- DEEP
- BLADE

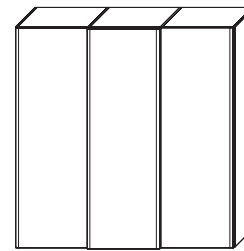

It is possible to make the external sliding door with two handles if using the "A FILO" or BLADE door (full-height handle) and applying the surcharge

Detail of side panel with extension profile

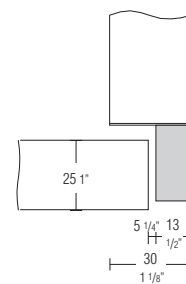

with BLADE door

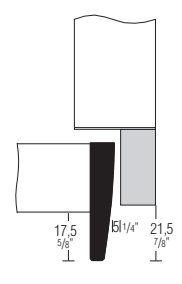

Flush sliding doors

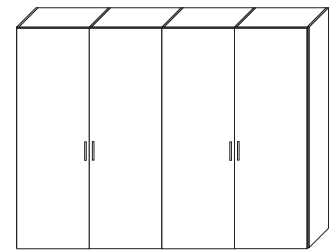
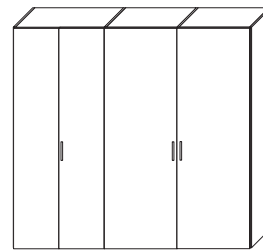
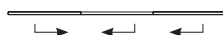
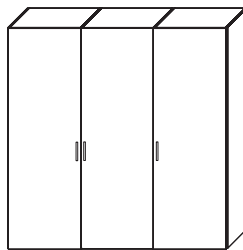
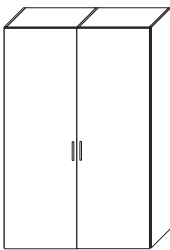

DOORS

155° opening (only for compartments with wooden sides)

On **START - TWIN - "A FILO" - GRIP - DEEP - NICHE** doors it is also possible to use **155° opening hinges, with an extra charge per individual door**. In this case, it is necessary to take special care in inserting internal drawer units, trinket trays and devices.

It is also necessary to comply with the diagrams provided here.

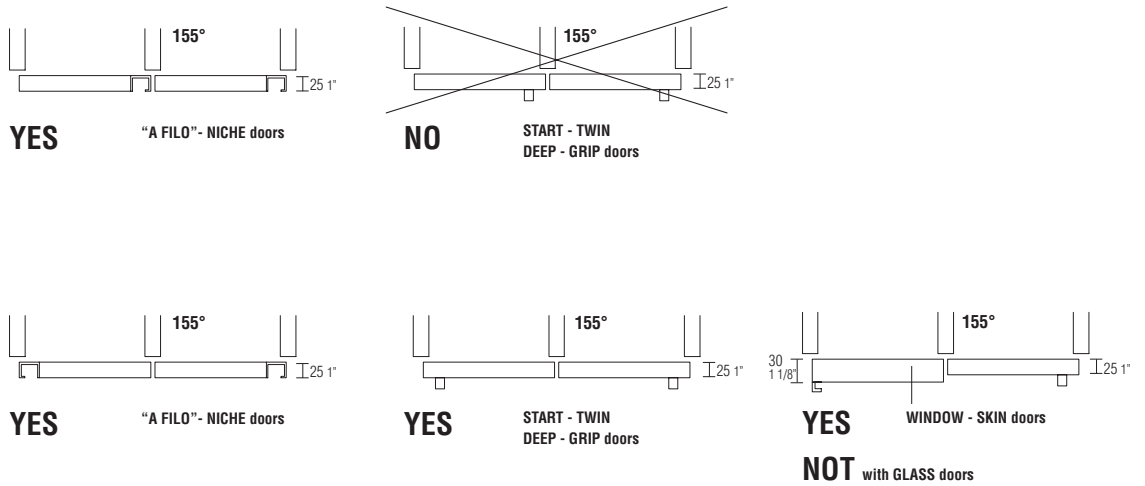

Hinged doors with key lock

For the hinged doors specified, a key lock can be fitted to order. There is a **additional cost for one or two doors**. It can even be fitted on a terminal element or a corner element (in compliance with the handle installation rules). For doors with a lock, the internal drawer units must be suspended. Installation of only the lock can be requested, without a handle, always considering the price of the START doors and the additional cost of the lock.

START door handle type "M"

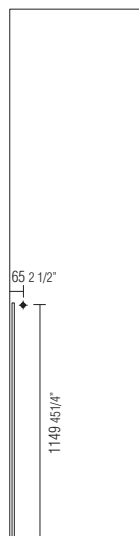

START door handle type "E"

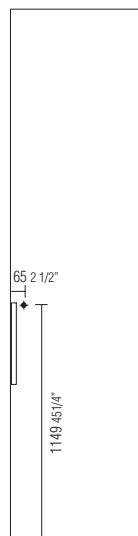

"A FILO" door

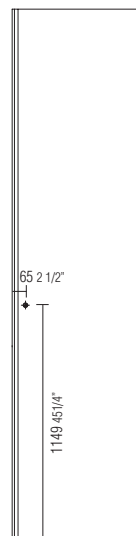

SISTEMA 7

A new folding opening system with a patented mechanism which makes it possible, in the 180° version, to open the unit entirely. The mechanism, light and silent, does not require tracks and therefore allows use of the full height.

The hinged doors enable 180° opening and wardrobe width made to order; the special hinge pins are anchored to the base and the cover.

Anyhow, SISTEMA 7 hinge doors can be used.

The 90° opening, on the other hand, is an intermediate solution that can solve design problems while maintaining a uniform design.

The thickness of the wood and glass door are 35 mm.

SISTEMA 7 can be applied to all Gliss Master structures with wood, glass or frame sides, but cannot be used with other Gliss Master doors.

The 90° and 180° folding door is applied to modules with width 790 and 954, while the hinged door is applied to single modules 380/462/626, double modules 790/954/1282 and the corner unit.

The 380 mm unit is specific for SISTEMA 7 with hinged door.

Reductions

90° and 180° folding openings can be reduced in height only.

180° hinged openings can be reduced in height and in width up to 405 mm.

Notes

The side panels follow the same logic as Gliss Master (see drawing ●).

★ = 180° Hinged (necessary for 180° opening and for wardrobes with width made to order)

90° Folding opening

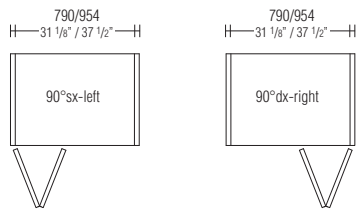

If the 90° folding door is on an end unit with external door, provide filler:
50 mm (790 compartment)
120 mm (954 compartment)

180° Folding opening

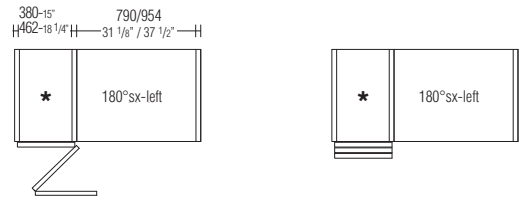

Mixed 90° / 180° Folding openings

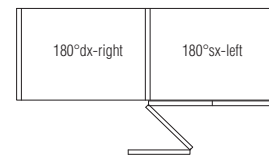
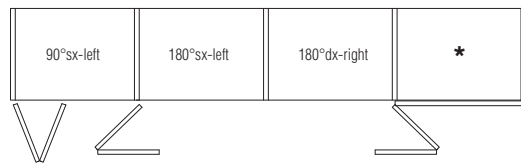

180° Corner opening

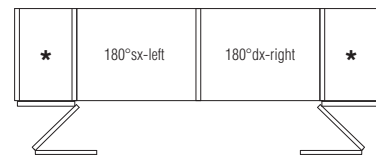
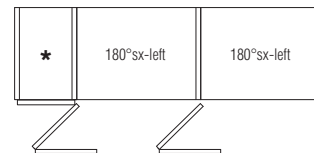
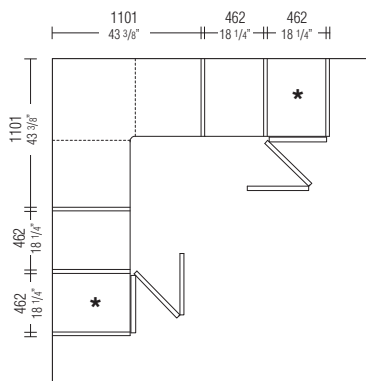

wooden side panels (●)

glass side panels (●)

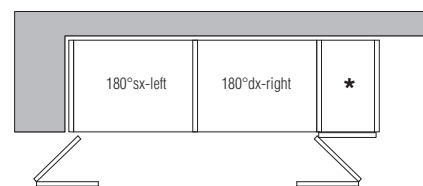

CORNER ELEMENT

Corner element D 595 - open or with GLASS/SWING/SISTEMA 7 doors

The corner element is provided complete with a base, lid and backs (melamine or fine grain). Between the corner element and the adjacent modules, it is necessary to insert central partitions in melamine, frame or glass.

The corner element can also receive a side panel to close the composition. Compartments adjacent to the closed corner element can be open or closed with GLASS, SWING or SISTEMA 7 (folding and hinged) doors.

Notes

The shelf is not included in the price of the corner element.
Shelves and lids can be fitted with LED lighting bars, as indicated in the drawing below.

Reductions

The corner element can be reduced in height, width and depth.

In width, the reduction can be carried out either on one side only or on both sides, up to a minimum width of 1101 mm.

Reduction in depth can be done on one or on two sides, up to a minimum of 435 mm. If only one side is reduced, that will be the side with the longest shelves (*).

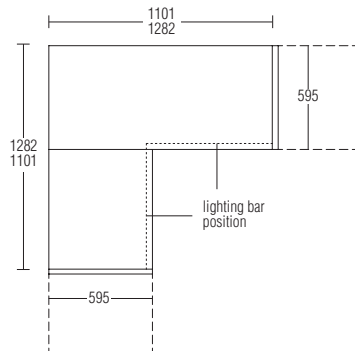
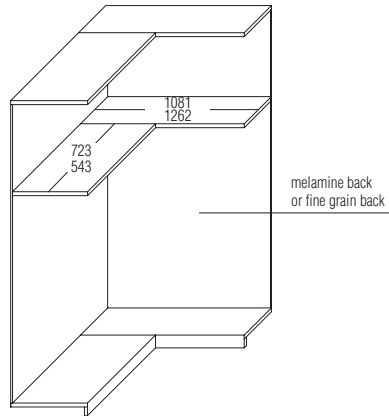
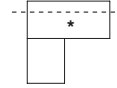

The corner element can be fitted with shelves and clothes rails, or with this solution of drawer units that have a central partition H 1158 where the desired drawer unit can be inserted. The drawer unit can be with fronts W 420 or 584.

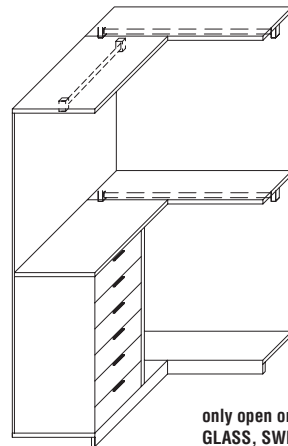

only open or with
GLASS, SWING and SISTEMA 7 doors

GLASS and SWING door

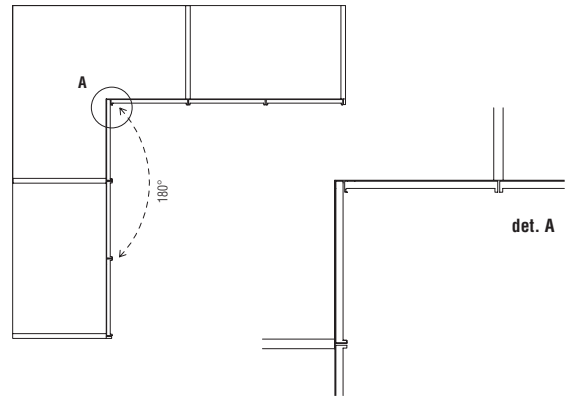

Solutions with SISTEMA 7 (only for corner unit 1101x1101)

180° Folding

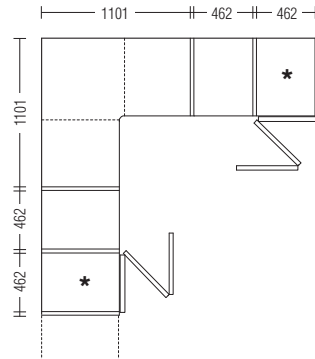

180° Hinged

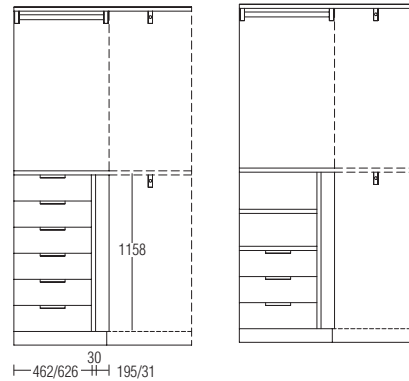
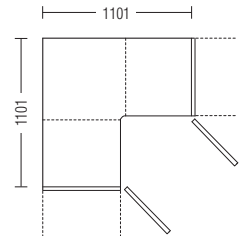

No type of drawer unit can be inserted with frame or glass sides

STRUCTURE

Structure for walk-in closet

In version **A**, the structure (base, lid, central partitions, back and side panels) is in melamine, in the same finish as the structure.

The back piece can also be provided in fine grain finish or in glass.

The side panels are always provided without extension profile (see detail).

In version **B**, the central partitions and sides are made with an aluminium frame with pewter colour or bronze finish, with or without glass.

Base, lid and back piece are in melamine, in the same finish as the structure.

The back piece can also be provided in fine grain or glass finish.

Horizontal tags on the base and lid are made in a pewter colour or bronze finish like the side frames.

In version **C**, given the presence of frame sides in pewter colour finish, the central and side partitions in melamine are also made with from tags in pewter colour or bronze.

10
49

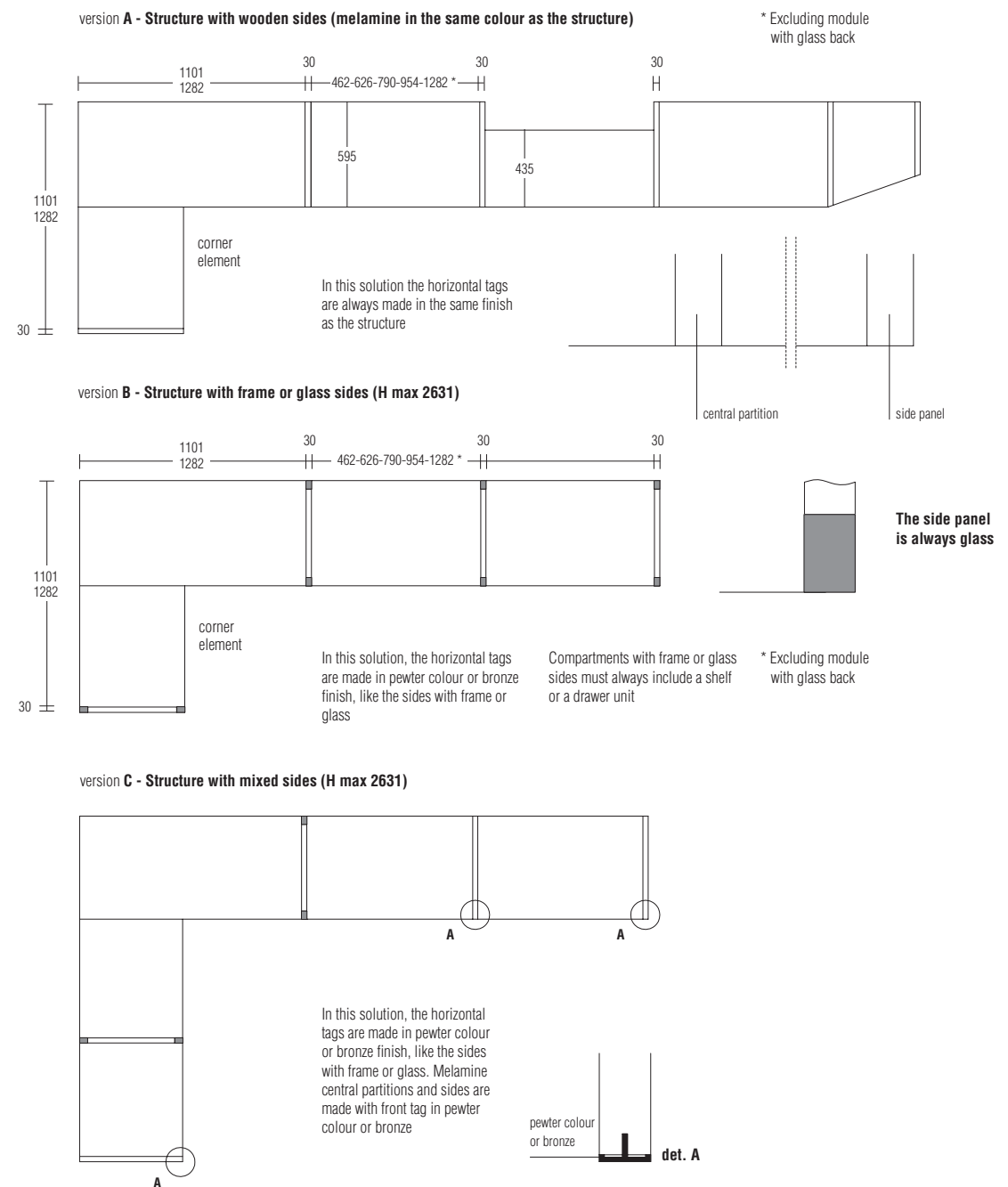

STRUCTURE

Linear modules

Linear modules are made up of a base and lid always made in melamine in the same finish as the structure.

The back is available in the three versions indicated below.

A1 and **A2** can be reduced in height, width and depth if closed by sides and doors that are compatible with the requested reductions.

A3 can be reduced only in height.

Central partitions

These are available in melamine, in the same finishes as the structure, frame and glass.

The melamine version can be reduced in height and depth.

The frame and glass versions can be reduced only in height.

Compartments with frame or glass sides must always include a shelf or a drawer unit.

Side panels

These are available in melamine, in the same finishes as the structure, frame and glass. The melamine version can be reduced in height and depth.

The outside of the side panel is available in the matt lacquer, glossy lacquer or wooden (vertical grain) finishes.

The standard finish on side panels is an extension profile in the coloured matt lacquer, pewter colour, bronze, shiny aluminium or black chrome finishes (to be specified in the Order). The extension profiles for glossy lacquer or wood side panels always match the side panels of the same finish.

The frame and glass versions can be reduced only in height.

Compartments with frame or glass sides must always include a shelf or a drawer unit.

A1 - Melamine back

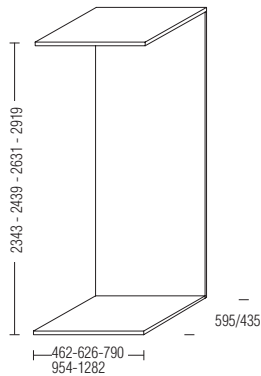

A1

Base, lid and back made in melamine finish matching the structure

A2 - Fine grain back

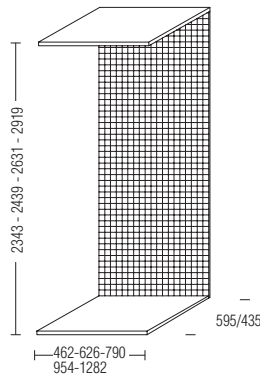

A2

Base and lid made in melamine finish matching the structure. Back with fine grain finish

A3 - Glass back

(only hinged GLASS, WINDOW closet and SISTEMA 7 glass)

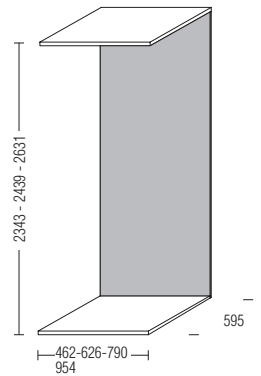

A3

Base and lid made in melamine finish matching the structure. It is possible to produce single finished modules W 790/954 with lateral pieces in glass by using the glass lids

Central partitions, th 30

Warning:

frame sides and glass sides will only have holes at the position of the shelves. Complete hole series at regular intervals 96 mm will involve an extra charge.

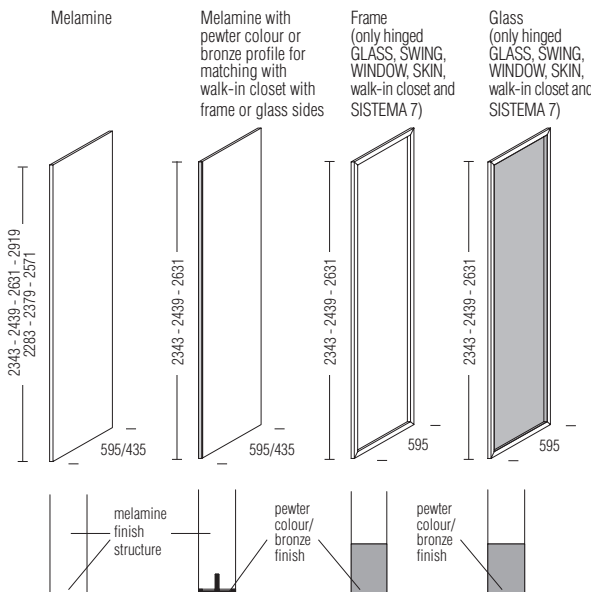

Side panels, th 30

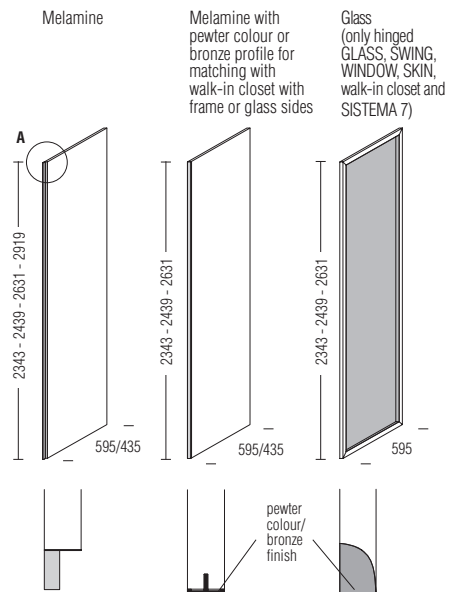

det. A

TWO-SIDED CORNER WARDROBE COMPOSITIONS WITH OUTWARD SWING DOORS

Many of the solutions described below can be created with Gliss Master.
These layouts can be installed either with or without the external corner module.

** For this side, please consider the wooden side panel surcharge.

12
49

Solution A:
Outward swing doors
(NO glass back panels)

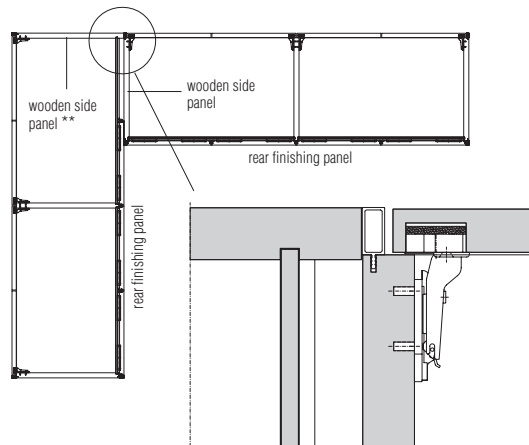

Solution B:
Outward swing door + Walk-in Closet
(NO glass back panels)

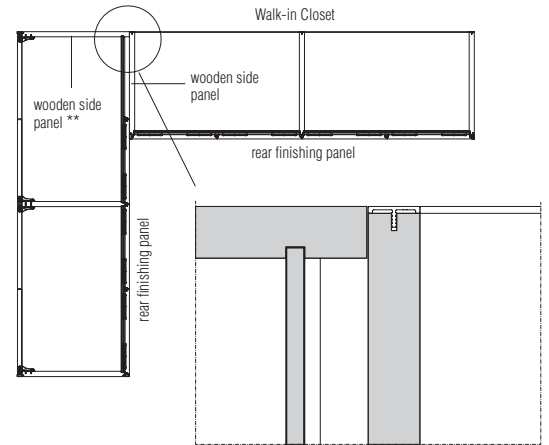

Solution C:
Outward swing door + Inward swing door
(example with glass back panels)

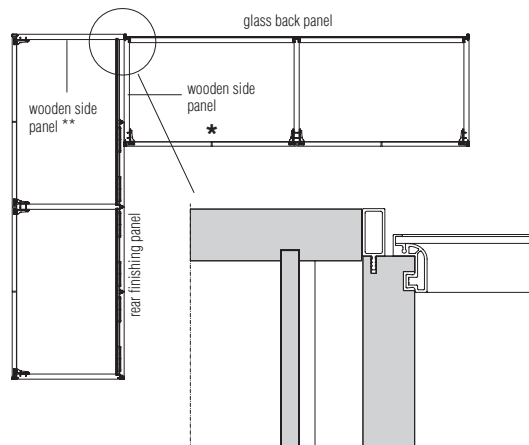

Solution D:
Outward swing door + Inward swing door
(example with rear finishing panel)

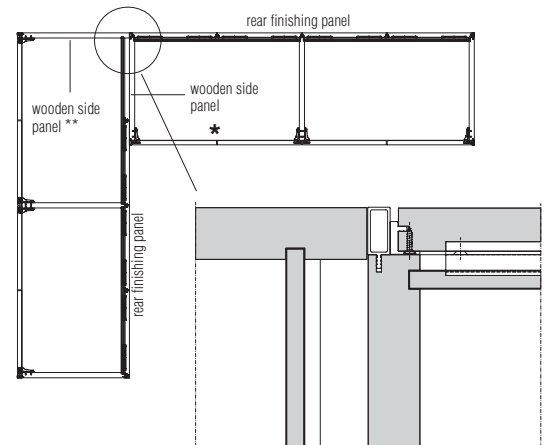

* This compartment can be closed with "A FILO" door and a NICHE door (vertical and horizontal).
For glass backs, drawer units are mandatory for compartments with frame or glass sides.
For melamine or fine grain backs, use the drawer unit with smaller width than the module.

EXTERNAL CORNER UNIT

External corner unit

- It can be either open or fitted with doors.
- It is always secured to the melamine central partitions of the adjacent wardrobes.
- The front profile can have a matt lacquered, pewter colour and bronze finish.
- Height, width and depth can be reduced.
- The external corner unit can be closed in all hinged door models.

Reductions

The external corner unit can be reduced in height, width and depth.

* For this side, please consider the wooden central partition surcharge.

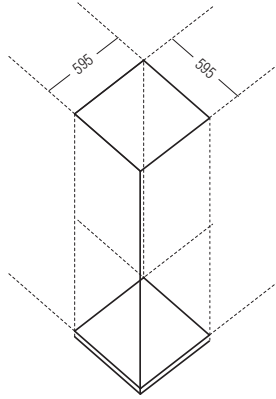

Solution A: with Doors

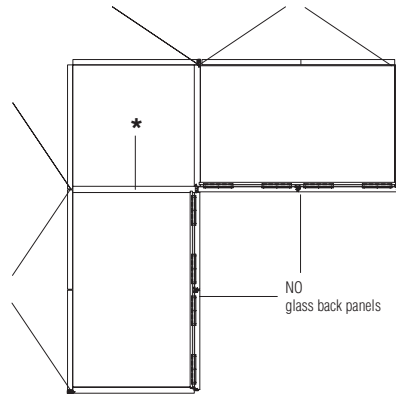

Solution C: Doors and Walk-in Closet

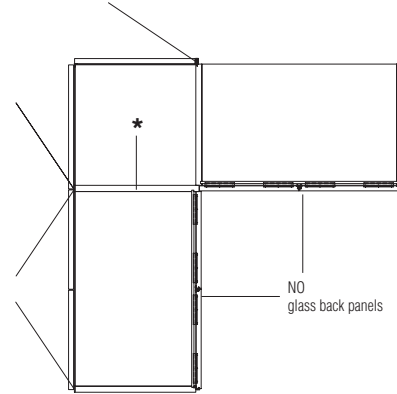

Solution B: Walk-in Closet

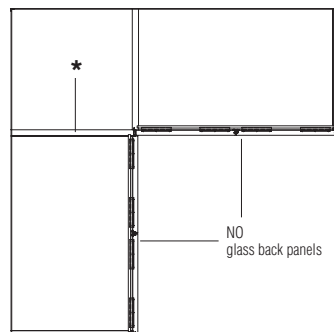

Solution D: Doors and Walk-in Closet

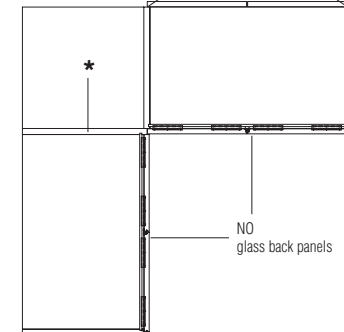

WARDROBE REDUCTIONS

Structure reductions

Type of reduction	height	width	depth
Linear modules D 595 mm melamine back or fine grain back	per millimetre	per millimetre	min -20 mm max -256 wardrobe / flush sliding ward. max -160 mm
Linear modules D 595 mm glass back	per millimetre	no reductions	no reductions
Linear elements D 435 mm	per millimetre	per millimetre	min -20 mm max -96 mm
Corner element for wardrobe with doors	per millimetre	no reductions	no reductions
Corner element open or for GLASS/SWING doors	per millimetre	1 side up to 1101 x 1282	1 side up to mm 435
		2 sides up to 1101 x 1101	2 sides up to mm 435
Terminal element	per millimetre	no reductions	no reductions
Wooden central partition or side panel	per millimetre		reductions depend on linear modules
Frame or glass side panel or central partition	per millimetre		no reductions
External corner unit	per millimetre	up to mm 435	up to mm 435

The retailer should remember to verify the stability of wardrobes having a depth inferior to 595 mm and arrange to have anti-tilt devices mounted if necessary.

Door reductions

Type of reduction	height	width
Wooden hinged doors (START - TWIN - "A FILO" - GRIP - DEEP - NICHE)	per millimetre	per millimetre
"A FILO" glass hinged doors	per millimetre	per millimetre
Wooden sliding doors (START - "A FILO" - BLADE - GRIP - DEEP)	per millimetre	ONLY doors W 979 and 1307 mm - reducible down to W 815 mm
"A FILO" glass sliding doors	per millimetre	no reductions
Wooden flush sliding doors (START - TWIN - "A FILO" - GRIP - DEEP) Flush sliding doors W 1471 mm cannot be reduced.	per millimetre	no reductions
"A FILO" glass flush sliding doors	per millimetre	no reductions
SKIN doors	no reductions	no reductions
WINDOW / GLASS / SWING doors	per millimetre	reducible down to W 405 mm
SISTEMA 7 wood hinged door	per millimetre	reducible down to W 405 mm
SISTEMA 7 wood folding door	per millimetre	no reductions
SISTEMA 7 glass hinged door	per millimetre	reducible down to W 405 mm
SISTEMA 7 glass folding door	per millimetre	no reductions

Reductions of internal fittings

Type of reduction	height	width	depth
Wood shelves		per millimetre	reductions depend on linear modules
Shelves with pewter colour profile		per millimetre	reductions depend on linear modules
Eco Skin shelves		per millimetre	reductions depend on linear modules
Glass shelves		per millimetre	reductions depend on linear modules
Clothes rails		per millimetre	
Central divider pieces	32 mm intervals		reductions depend on linear modules
Internal drawers / trinket trays, trouser holders and pull-out trays / grid with shirt and sweater holders / shoe rack shelves / pull-out shirt holders / lighting shelves / islands / movable trays	no reductions	no reductions	no reductions

* If the corner shelves are reduced on two sides, consider double the cost.

Lighting bars can be reduced with a surcharge included in the fee for cutting the shelf.

Cuts to measure

Diagonal cut doors (only for wardrobes with wooden sides)

When compiling the order, indicate the heights H1 and H2 and the width L as in the example.

The cost of a diagonal cut for each single door is the same as that for the hinged door in the table on page of the doors.

Compositions with diagonal slant are always built with single-door compartments. Only fitted with START, TWIN, "A FILO", GRIP or DEEP hinged doors. Doors must be hinged to the highest side panel. The door finish options for slanted wardrobes are restricted to cartapaglia, matt lacquer and matt lacquered cartapaglia. Structures can be either in standard sizes or customised.

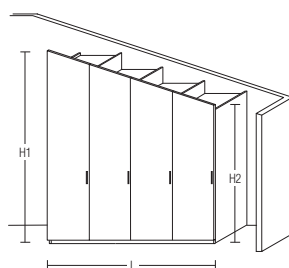

Standard or cut-to-size doors (only for wardrobes with wooden sides)

For these solutions you can use either single or double units with hinged doors.

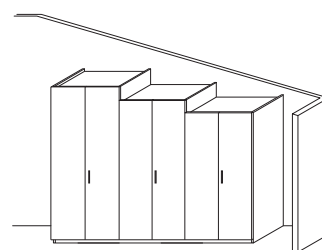

GLASS TOP FOR WARDROBES FINISHED WITH ONLY ONE COMPARTMENT W 790/954

To use only with:

- single linear module W 790 / W 954
(no modular arrangement is possible)
- only with glass lateral pieces and glass back panel
- clothes rod cannot be mounted on the lid
- cannot be used with SISTEMA 7 doors

Glass finish

- transparent glass
- transparent stopsol glass
- stopsol glass

Profile finish

- pewter colour
- bronze

Increase valid for depths 595 - 23 3/8"



W 790 - 31 1/8"

W 954 - 37 1/2"

START door th 25

Door with handles mounted on the front.

All the hinged doors have cushion-closing hinges.

The sliding door have a shock absorber mechanism which allows them to open and close softly.
Hinges with 155° opening can be used and a key lock can be installed on hinged doors.

Handles

Type "E"
 Type "M"

Notes

Sliding doors and flush sliding doors are not available in H 2889.

With fronts in cartapaglia melamine, graffiato, silk and lacquered cartapaglia finishes, the outside of the side panel can be made with matt lacquer finish (in the same colour as the front), or in melamine in the same finish as the inside structure (if the side panel is not visible).

START door

melamine cartapaglia
 melamine graffiato
 melamine silk
 matt lacquer colours
 cartapaglia lacquered colours
 glossy lacquer colours
 vertical grain wood

Type "E"

standard

Pewter colour structure with front insert:

pewter colour
 matt lacquer colours
 woods
 coloured glass
 etched coloured glass

Structure and front insert:

shiny aluminium
 black chrome
 bronze

Type "M"

surcharge for each

Finish

pewter colour
 shiny aluminium
 black chrome
 bronze

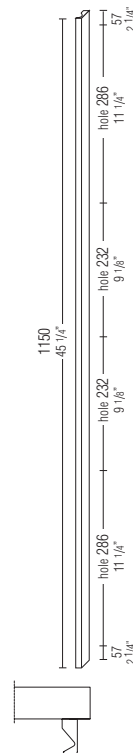
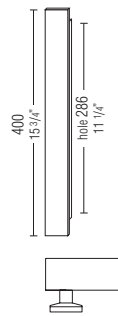
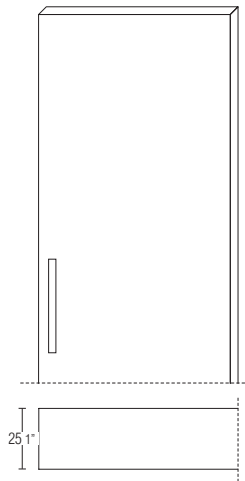

finishes

melamine front matt lacquer colours cartapaglia lacquered colours vertical grain wood glossy lacquer colours

hinged doors

width 487 (19 1/8")					
w. 651 (25 5/8") 608 (23 7/8")					
width 815 (32 1/8")					
width 979 (38 1/2")					
width 1307 (51 1/2")					
door for terminal element					

sliding doors

width 815 (32 1/8")					
width 979 (38 1/2")					
width 1307 (51 1/2")					
width 1471 (57 7/8")					

flush sliding doors

width 815 (32 1/8")					
width 979 (38 1/2")					
width 1307 (51 1/2")					
width 1471 (57 7/8")					

TWIN door th 25

Door with pewter colour or bronze finish handle mounted on the front.

All the hinged doors have cushion-closing hinges. The sliding door have a shock absorber mechanism which allows them to open and close softly.

Hinges with 155° opening can be used and a key lock can be installed on hinged doors.

Notes

Flush sliding doors are not available in H 2889.

With fronts in cartapaglia melamine, graffiato, silk and lacquered cartapaglia finishes, the outside of the side panel can be made with matt lacquer finish (in the same colour as the front), or in melamine in the same finish as the inside structure (if the side panel is not visible).

TWIN door

melamine cartapaglia
melamine graffiato
melamine silk
matt lacquer colours
cartapaglia lacquered colours
glossy lacquer colours
vertical grain wood

Handle finish

pewter colour
bronze

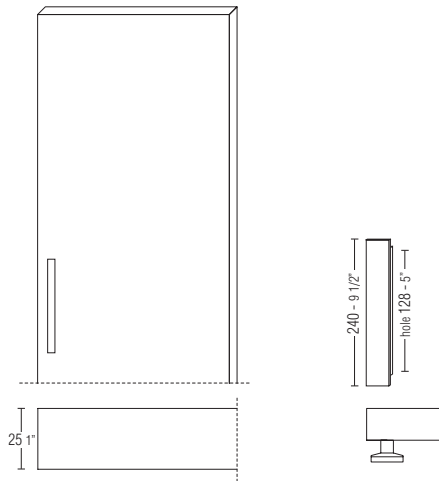

17—
49

finishes

	melamine front	matt lacquer colours	cartapaglia lacquered colours	vertical grain wood	glossy lacquer colours
hinged doors					
width 487 (19 1/8")					
w. 651 (25 5/8") 608 (23 7/8")					
width 815 (32 1/8")					
width 979 (38 1/2")					
width 1307 (51 1/2")					
door for terminal element					
flush sliding doors					
width 815 (32 1/8")					
width 979 (38 1/2")					
width 1307 (51 1/2")					
width 1471 (57 7/8")					

“A FILO” door th 25

Door with full-height handle included in the thickness of the door.
The door is available in the versions wood and glass.

All the hinged doors have cushion-closing hinges.
The sliding door have a shock absorber mechanism which allows them to open and close softly.
Hinges with 155° opening can be used and a key lock can be installed on hinged doors.

Notes

Sliding doors and flush sliding doors are not available in H 2889.
Glass hinged doors are not available in H 2889.
Flush sliding glass doors cannot be used in compositions with 3 doors.

With fronts in cartapaglia melamine, graffiato, silk and lacquered cartapaglia finishes, the outside of the side panel can be made with matt lacquer finish (in the same colour as the front) or in melamine in the same finish as the inside structure (if the side panel is not visible).

“A FILO” wooden door

melamine cartapaglia
melamine graffiato
melamine silk
matt lacquer colours
cartapaglia lacquered colours
glossy lacquer colours
vertical grain wood

“A FILO” glass door

Glass:
coloured
etched coloured
mirror

Profile and “a filo” handle:
pewter colour
bronze

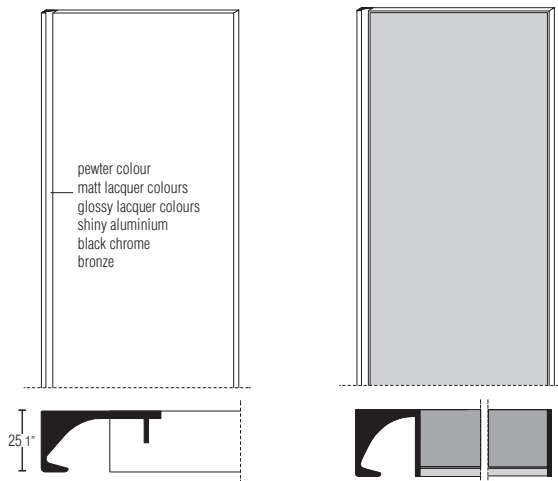

finishes

	melamine front	matt lacquer colours	cartapaglia lacquered colours	vertical grain wood	glossy lacquer colours	coloured glass/ etched coloured glass/ mirror
hinged doors						
width 487 (19 1/8")						
w. 651 (25 5/8") 608 (23 7/8")						
width 815 (32 1/8")						
width 979 (38 1/2")						
width 1307 (51 1/2")						
door for terminal element						
sliding doors						
width 815 (32 1/8")						
width 979 (38 1/2")						
width 1307 (51 1/2")						
width 1471 (57 7/8")						
flush sliding doors						
width 815 (32 1/8")						
width 979 (38 1/2")						
width 1307 (51 1/2")						
width 1471 (57 7/8")						

BLADE sliding door th 25

Door with full-height handle.

The sliding system automatically aligns the door as it opens and closes.

Notes

BLADE doors are not available with H 2889.

With fronts in cartapaglia melamine, graffiato, silk and lacquered cartapaglia finishes, the outside of the side panel can be made with matt lacquer finish (in the same colour as the front), or in melamine in the same finish as the inside structure (if the side panel is not visible).

BLADE sliding door

melamine cartapaglia
melamine graffiato
melamine silk
matt lacquer colours
cartapaglia lacquered colours
glossy lacquer colours
vertical grain wood

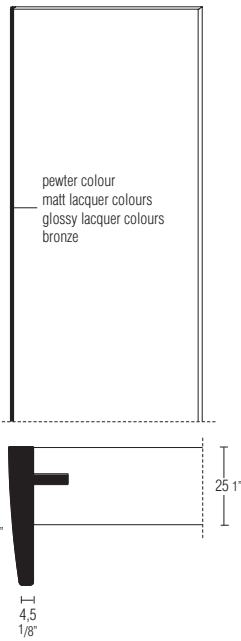

19 —
49

finishes

	melamine front	matt lacquer colours	cartapaglia lacquered colours	vertical grain wood	glossy lacquer colours
sliding doors					
width 815 (32 1/8")					
width 979 (38 1/2")					
width 1307 (51 1/2")					
width 1471 (57 7/8")					

GRIP door th 25 DESIGN VINCENT VAN DUYSSEN

Door with a handle applied laterally on the edge of the door.

All the hinged doors have cushion-closing hinges.

The sliding door have a shock absorber mechanism which allows them to open and close softly.

Hinges with 155° opening can be used on hinged doors.

Notes

Sliding doors and flush sliding doors are not available in H 2889.

In the pair of hinged doors, the handle is mounted on both doors in the pair.

With fronts in cartapaglia melamine, graffiato, silk and lacquered cartapaglia finishes, the outside of the side panel can be made with matt lacquer finish (in the same colour as the front), or in melamine in the same finish as the inside structure (if the side panel is not visible).

Handles finishes

pewter colour

bronze

pewter colour covered in Eco Skin in the colours (with surcharge per handle)

bronze covered in Eco Skin in the colours (with surcharge per handle)

GRIP door

melamine cartapaglia

melamine graffiato

melamine silk

matt lacquer colours

cartapaglia lacquered colours

glossy lacquer colours

vertical grain wood

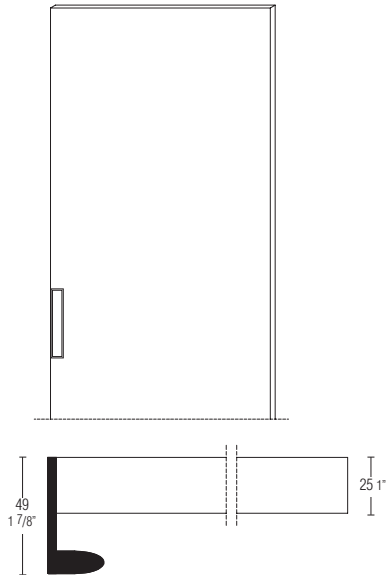

finishes

	melamine front	matt lacquer colours	cartapaglia lacquered colours	vertical grain wood	glossy lacquer colours
hinged doors					
width 487 (19 1/8")					
w. 651 (25 5/8") 608 (23 7/8")					
width 815 (32 1/8")					
width 979 (38 1/2")					
width 1307 (51 1/2")					
door for terminal element					
sliding doors					
width 815 (32 1/8")					
width 979 (38 1/2")					
width 1307 (51 1/2")					
width 1471 (57 7/8")					
flush sliding doors					
width 815 (32 1/8")					
width 979 (38 1/2")					
width 1307 (51 1/2")					
width 1471 (57 7/8")					

DEEP door th 25 DESIGN VINCENT VAN DUYSSEN

Door with recessed handle.

All the hinged doors have cushion-closing hinges.
The sliding door have a shock absorber mechanism which allows them to open and close softly.
Hinges with 155° opening can be used on hinged doors.

Notes

Sliding doors and flush sliding doors are not available in H 2889.

In the pair of hinged doors, the handle is mounted on both doors in the pair.

With fronts in cartapaglia melamine, graffiato, silk and lacquered cartapaglia finishes, the outside of the side panel can be made with matt lacquer finish (in the same colour as the front) or in melamine in the same finish as the inside structure (if the side panel is not visible).

Handles finishes

pewter colour

bronze

pewter colour covered in Eco Skin in the colours (with surcharge per handle)

bronze covered in Eco Skin in the colours (with surcharge per handle)

DEEP door

melamine cartapaglia

melamine graffiato

melamine silk

matt lacquer colours

cartapaglia lacquered colours

glossy lacquer colours

vertical grain wood

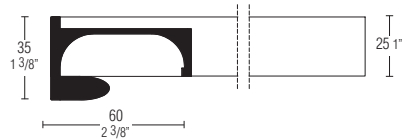
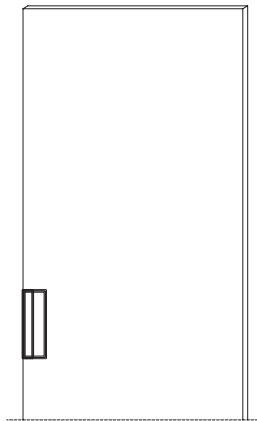

21 —
49

finishes

	melamine front	matt lacquer colours	cartapaglia lacquered colours	vertical grain wood	glossy lacquer colours
hinged doors					
width 487 (19 1/8")					
width 651 (25 5/8")/608 (23 7/8")					
width 815 (32 1/8")					
width 979 (38 1/2")					
width 1307 (51 1/2")					
door for terminal element					
sliding doors					
width 815 (32 1/8")					
width 979 (38 1/2")					
width 1307 (51 1/2")					
flush sliding doors					
width 815 (32 1/8")					
width 979 (38 1/2")					
width 1307 (51 1/2")					

NICHE door th 25 DESIGN VINCENT VAN DUYSSEN

Door with recessed handle.

All the hinged doors have cushion-closing hinges.

Hinges with 155° opening can be used on hinged doors.

Handles finishes

pewter colour
bronze

NICHE door
matt lacquer colours
glossy lacquer colours
vertical grain wood

22—
49

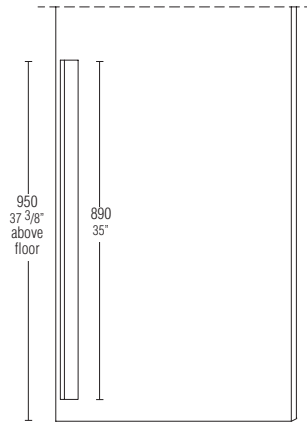

finishes

matt lacquer colours vertical grain wood glossy lacquer colours

hinged doors

	matt lacquer colours	vertical grain wood	glossy lacquer colours
width 487 (19 1/8")			
width 651 (25 5/8")/608 (23 7/8")			
width 815 (32 1/8")			
width 979 (38 1/2")			
width 1307 (51 1/2")			
door for terminal element			

NICHE HORIZONTAL door th 25 DESIGN VINCENT VAN DUYSEN

Door with recessed horizontal handle.

All the hinged doors have cushion-closing hinges.

Hinges with 155° opening can be used on hinged doors.

Handles finishes

pewter colour
bronze

NICHE horizontal door
matt lacquer colours
glossy lacquer colours

23—
49

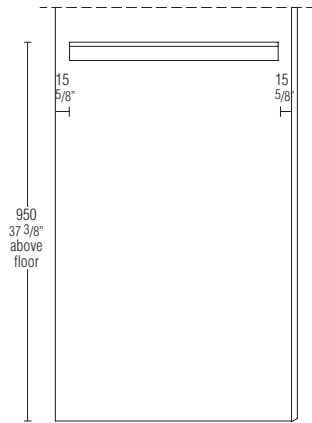

hinged doors	finishes	
	matt lacquer colours	glossy lacquer colours
width 487 (19 1/8")		
width 651 (25 5/8"), 608 (23 7/8")		
width 815 (32 1/8")		
width 979 (38 1/2")		
width 1307 (51 1/2")		
door for terminal element		

GLASS door, th 35, 180° opening DESIGN VINCENT VAN DUYSEN

Glass door with 180° opening made with a special soft close hinge inserted in the profile and completely hidden in the side (exclusively by Molteni).
A full height handle is designed in the profile.

Notes

The GLASS doors are available with H 2889 only for widths 487, 815, 979 and for the corner unit 1101x1101.
In the pair of hinged doors, the handle is mounted on both doors in the pair.

Integrated lock with encrypted key

GLASS hinged doors with integrated lock are available, taking into account a surcharge for single door or pair of doors.
As standard, all lockable doors in a wardrobe will have different encrypted keys.
On the pair of doors, the lock will always be applied to the right door.
The lock is not applicable to hinged doors of the external corner units.

The GLASS door can also be installed on the open corner module.

GLASS door

24 —
49

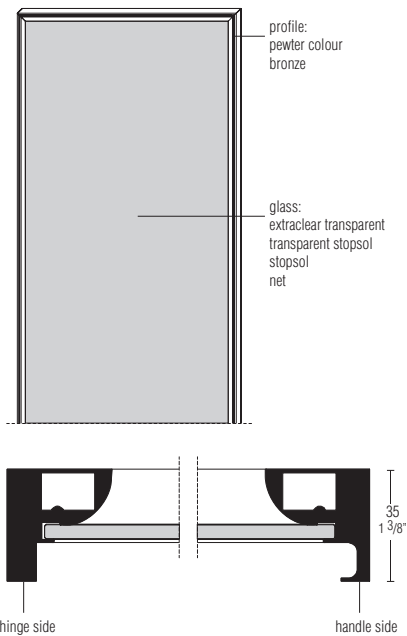

finishes

180° Hinged	finishes			
	transparent glass	transparent stopsol glass	stopsol glass	net glass
width 487 (19 1/8")				
w. 651 (25 5/8")/608 (23 7/8")				
width 815 (32 1/8")				
width 979 (38 1/2")				
width 1307 (51 1/2")				
corner unit 1101x1101				
corner unit 1231x1231				

SWING door, th 35, 180° opening DESIGN VINCENT VAN DUYSSEN

Matt lacquered door with panel and perimeter profiles with a 180° opening made with a special soft close hinge inserted in the profile and completely hidden in the side (exclusively by Molteni). A full height handle is designed in the profile.

Notes
SWING doors are not available in H 2889.
In the pair of hinged doors, the handle is mounted on both doors in the pair.

The SWING door can also be installed on the open corner module.

SWING door

25—
49

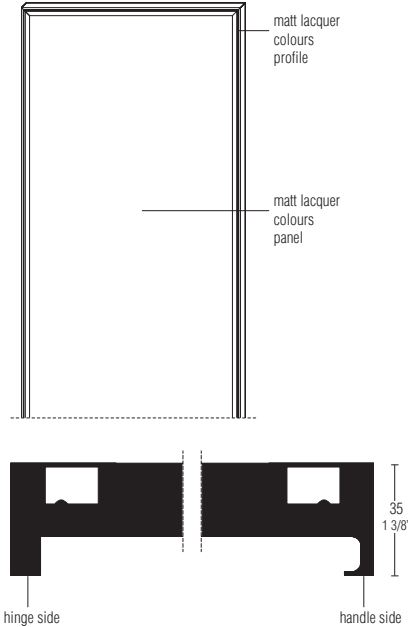

WINDOW door th 30 DESIGN VINCENT VAN DUYSSEN

Glass hinged door with pewter colour finished aluminium frame and lateral handle.

The doors are fitted with recessed hinges inserted in the base and top.

Notes

WINDOW doors are not available in H 2889.

In the pair of hinged doors, the handle is mounted on both doors in the pair.

Handle finishes

pewter colour

bronze

pewter colour covered in Eco Skin in the colours (with surcharge per handle)

bronze covered in Eco Skin in the colours (with surcharge per handle)

WINDOW glass door

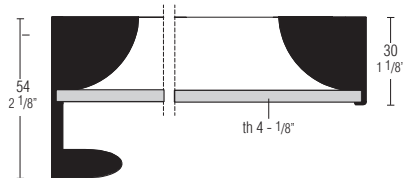
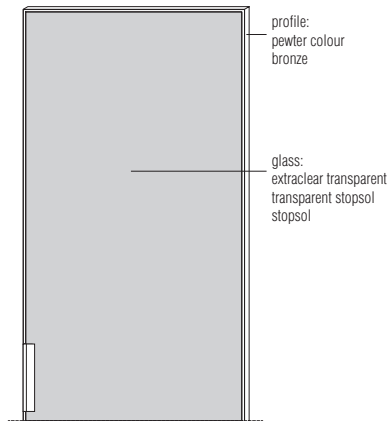

finishes

hinged doors	finishes		
	transparent glass	transparent stopsol glass	stopsol glass
width 487 (19 1/8")			
width 651 (25 5/8")/608 (23 7/8")			
width 815 (32 1/8")			
width 979 (38 1/2")			
width 1307 (51 1/2")			
door for terminal element			

SKIN hinged door th 30 DESIGN VINCENT VAN DUYSSEN

Eco Skin covered hinged door with pewter colour and bronze finished aluminium frame and lateral handle.

The doors are fitted with recessed hinges inserted in the base and top.

The door is always divided into 3 equal parts.

Notes

SKIN doors are not available in H 2889.

In the pair of doors, the handle is mounted on both doors in the pair.

Handle finishes

pewter colour

bronze

pewter colour covered in Eco Skin in the colours (with surcharge per handle)

bronze covered in Eco Skin in the colours (with surcharge per handle)

SKIN hinged door

27—
49

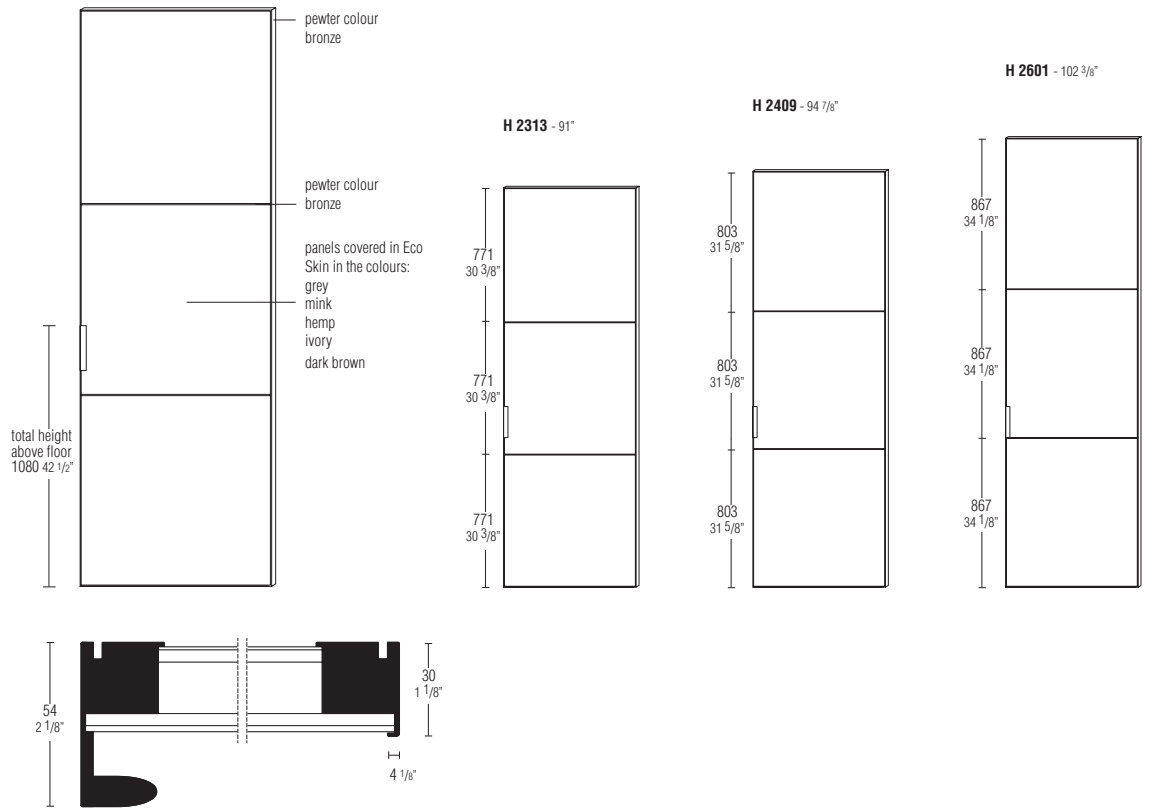

SISTEMA 7 wood doors th 35 DESIGN VINCENT VAN DUYSEN

Doors characterised by increased thickness, made in structural honeycombed panels that make the surface perfectly flat.
Patented folding system.
All doors are fitted with soft-closing mechanism.

Notes

Doors are not available with H 2889.

SISTEMA 7 wood doors

matt lacquer colours
glossy lacquer colours
wood

90° / 180° Folding

180° Hinged

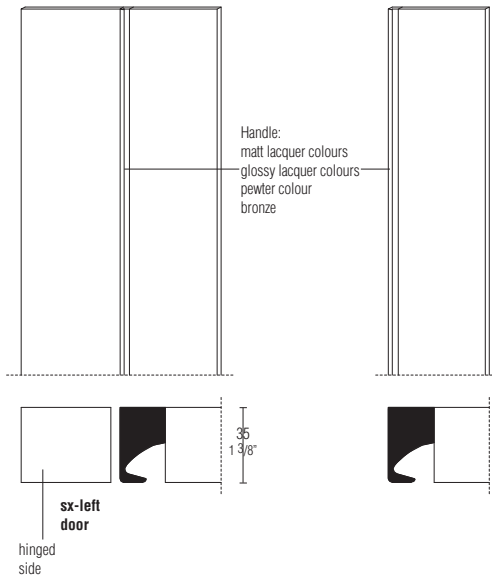

finishes

	matt lacquer colours	glossy lacquer colours	vertical grain wood
180° Folding			
width 815 (32 1/8")			
width 979 (38 1/2")			
corner unit 1101x1101			
90° Folding			
width 815 (32 1/8")			
width 979 (38 1/2")			
180° Hinged			
width 405 (16")			
width 487 (19 1/8")			
w. 651 (25 5/8")/608 (23 7/8")			
width 815 (32 1/8")			
width 979 (38 1/2")			
width 1307 (51 1/2")			
corner unit 1101x1101			

SISTEMA 7 glass doors th 35 DESIGN VINCENT VAN DUYSSEN

Glass door with aluminium outer profile, th 35 mm.
Patented folding mechanism.
All doors are equipped with soft-closing system.

Notes

Doors are not available with H 2889.

Integrated lock with encrypted key

Hinged doors with 180° opening and 90° / 180° folding doors are available with integrated lock, considering a surcharge for single door or pair of doors.
As standard, all lockable doors in a wardrobe will have different encrypted keys.
On the pair of hinged doors, the lock will always be applied to the right door.
On the 90° / 180° folding doors it will be applied to the upright opposite to the handle (see section).
The lock is not applicable to hinged doors of the external corner units.

SISTEMA 7 glass doors

90° / 180° Folding

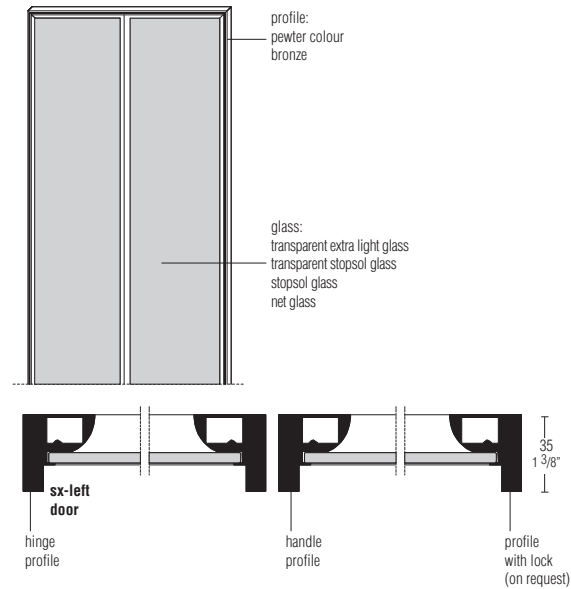

180° Hinged

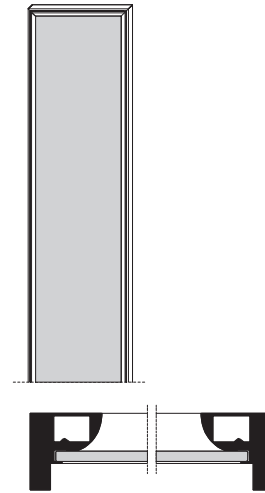

finishes

	transparent glass	transparent stopsol glass	stopsol glass	net glass
180° Folding				
width 815 (32 1/8")				
width 979 (38 1/2")				
corner unit 1101x1101				
90° Folding				
width 815 (32 1/8")				
width 979 (38 1/2")				
180° Hinged				
width 405 (16")				
width 487 (19 1/8")				
w. 651 (25 5/8")/608 (23 7/8")				
width 815 (32 1/8")				
width 979 (38 1/2")				
width 1307 (51 1/2")				
corner unit 1101x1101				

SISTEMA 7 doors th 35

With SISTEMA 7 it is possible to create passageway solutions with doors fastened to Gliss Master wardrobe structures.
This type of solution requires the insertion of a lid between the sides of the wardrobes.
It can be opened thanks to a 180° folding door in wood or glass.

Notes

Doors are not available with H 2889.

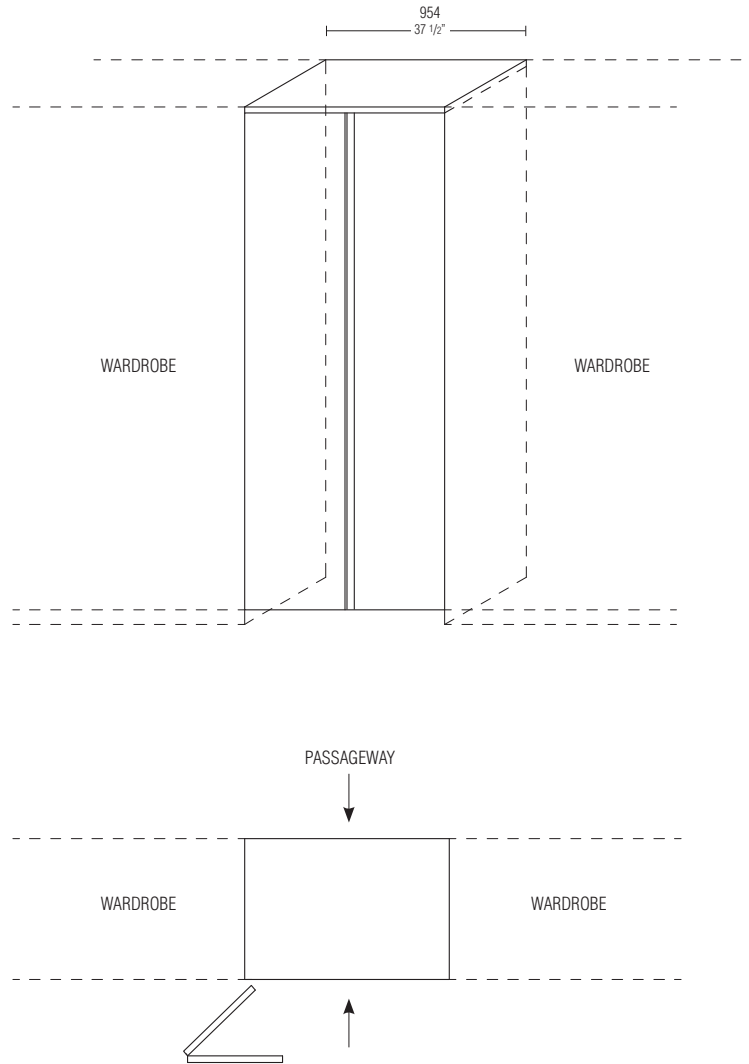

SPECIAL ELEMENTS

Column with open compartment

- Can be inserted only in wardrobes without doors or with hinged doors.
- Central partitions and/or lateral pieces close the column and cannot be frame or glass.
- The open compartment is always in matt lacquered colours.
- Doors are always without handles because they protrude with respect to the structure.
- Drawers are fitted with the "E" handle of the START door.
- Front finish: melamine front, matt lacquered colours, glossy lacquered colours and wood.

* **The price does not include the central partitions or side panels, nor the internal shelves.**

Reductions

Reductions are allowed only in height, and costs of cutting the structure and doors are applied. Open compartment and lower part cannot be reduced.

Wire passage **EPA1** Ø 60 chrome on request on back.

Notes

The back of the open compartment cannot hold a mounted TV.

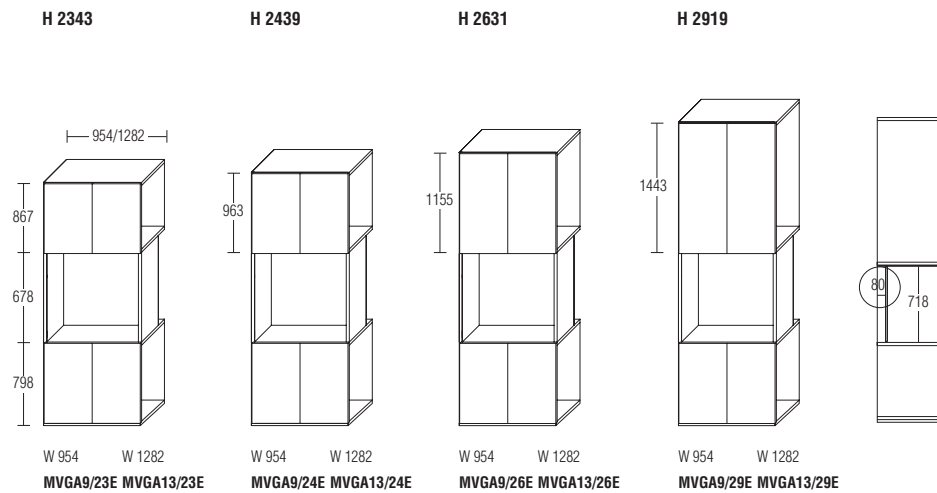
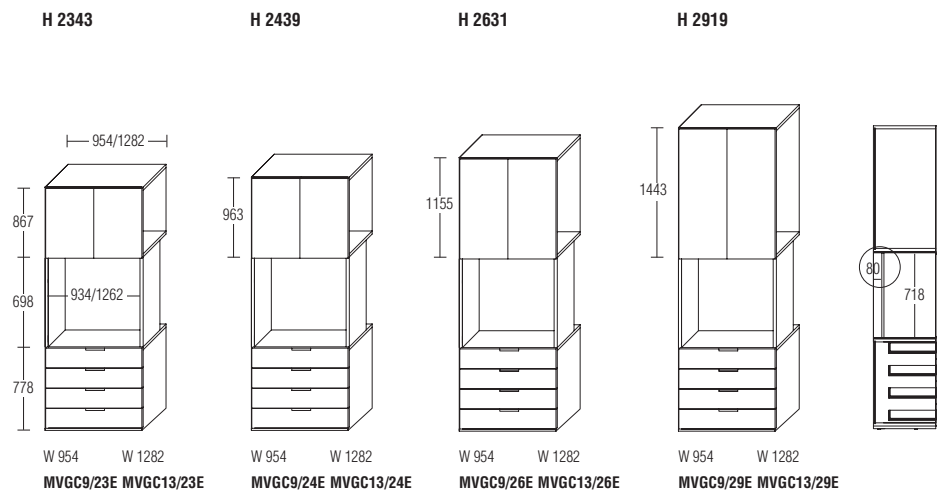

SPECIAL ELEMENTS

Column with external drawers

- Can be inserted only in wardrobes with hinged doors.
- Central partitions and/or lateral pieces close the column and cannot be frame or glass.
- Pairs of doors always have only one handle mounted on the right door.
- Drawers are fitted with the "E" handle of the START door.
- Front finish: melamine front, matt lacquered colours, glossy lacquered colours and wood.

Reductions

Reductions are allowed only in height, and costs of cutting the structure and doors are applied.

* The price does not include the central partitions or side panels, nor the internal shelves.

Doors with type "E" handle

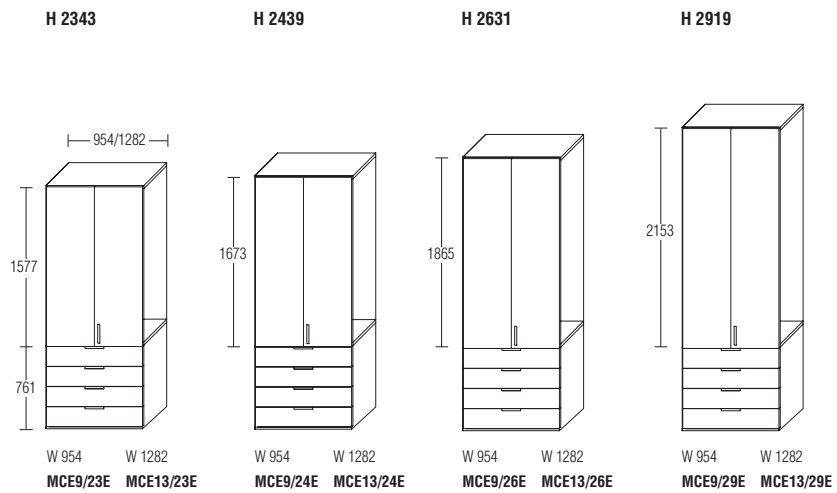

Doors with "A FILO" handle

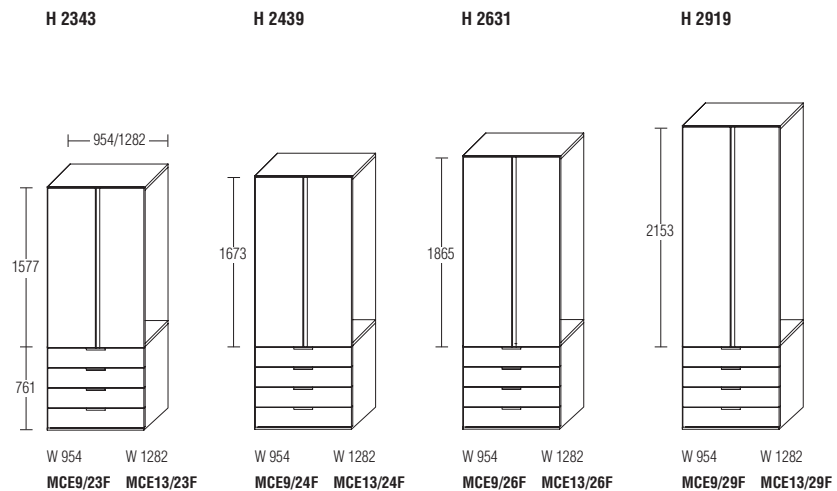

FILLERS AND OPENING SIDE TRIMS

Horizontal filler

The filler is supplied in two parts, one part to be fixed to the ceiling to which the other will be hooked on (see diagram below).

The distance of the filler from the door is the client's decision.

In the cartapaglia finish, the grain direction is always vertical.

In the wood and graffiato finish, the grain direction is always horizontal.

If this detail is not specified when placing the order, the filler will automatically be placed flush with the structure and the side panel will have the extension profile.

Opening fillers

Can be made with START and "A FILO" door. For handles, see surcharge.

Always have the 155° hinges.

Are the same height as the other doors in the composition.

Have a closing strip on their lower part.

In the wood finish, the grain direction is always vertical.

Horizontal filler side sections

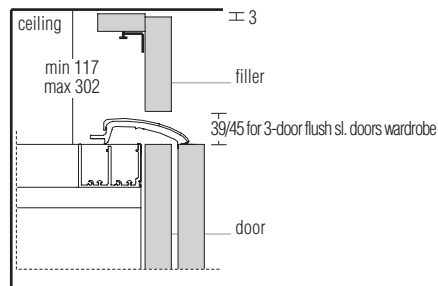
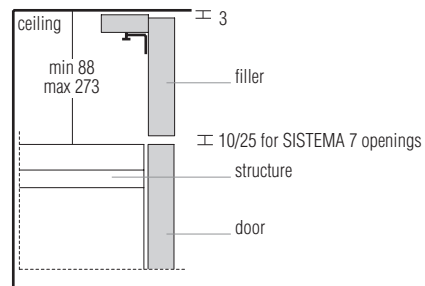

Vertical filler horizontal sections

Flush with structure

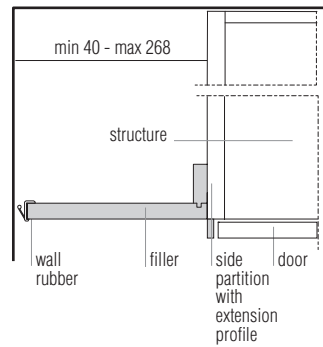

Flush with door

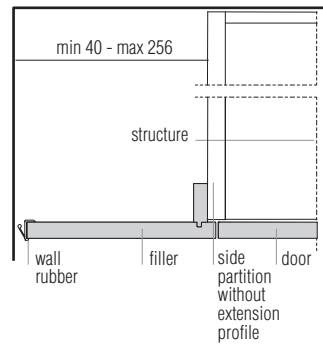

Set back

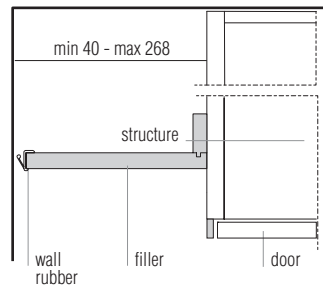

Opening filler horizontal sections

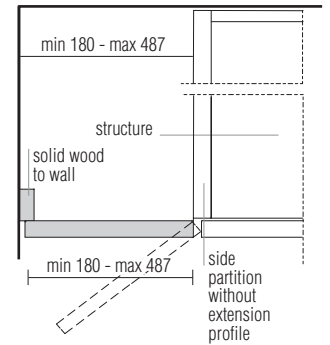

LIGHTING SYSTEM

Lighting bars with front LEDs

Internal compartments of Gliss Master wardrobes can be equipped with front LED lighting. The lighting bar can be applied to lids or to wooden, transparent glass and Eco Skin shelves. Using the electrified wire strip installed on the side (wood, frame or glass), the shelf can be moved. For each compartment length, we have made specific lighting bars with wiring compliant with European safety standards.

A wire strip is not needed if the compartment only has lighting on the top piece.

Lighting bars can be reduced with a surcharge for the shelf cutting.

Lighting shelves

It is possible to insert one or more lighting shelves in Gliss Master compartments. Using the electrified wire strip mounted on the side panel, the lighting shelf can be moved.

Lighting shelves can be connected to the wire strip on the left side panel or can be mounted without wire strip.

Notes





When placing the order, the customer must indicate how many shelves with lighting bars or lighting shelves are required. Lighting bars or lighting shelves can be placed in the same compartment. **For assembly: a lighting system on wardrobe with hinged doors requires a minimum extra height of 5 cm (2").**

Individual wire strip is always installed on the left side panel of the compartment, with the exception of corner units for walk-in wardrobes and of the compartment next to the corner unit.

When ordering, indicate compartments with wire strip.

The electrified wire strip is mandatory for wardrobes with wooden sides and glass back.

lighting bars 3000 K	W 380 5 watt	W 462 6 watt	W 626 8 watt	W 790 10 watt	W 954 12 watt	W 1282 16 watt	open corner element 20 watt	external corner unit 16 watt
								
	EBI2C	EBI4C	EBI6C	EBI8C	EBI9C	EBI13C	EBA13C	EBB6C

lighting shelves D 538 th 30 3000 K	W 626 12 watt	W 790 15 watt	W 954 18 watt	W 1282 30 watt
				
	RSL/6C	RSL/8C	RSL/9C	RSL/13C

components per system

(see the diagram for component use and to calculate system cost)

power supply unit 100W



sensor



electrified wire strip (max 6 lighting bars)



connector



radio control kit with brightness setting (1 per power supply unit) optional



power supply unit block 100W with watertight box for wardrobe with glass top optional

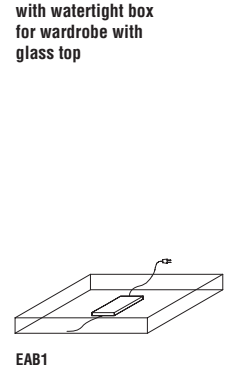

position of bar and wire strip on wooden partitions

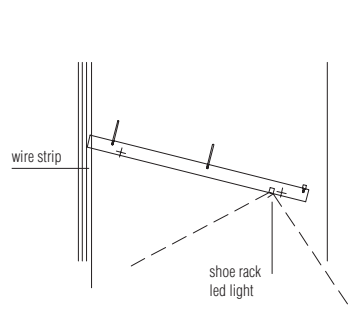
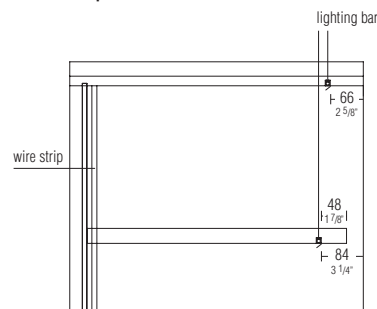

position of bar and wire strip on glass partitions

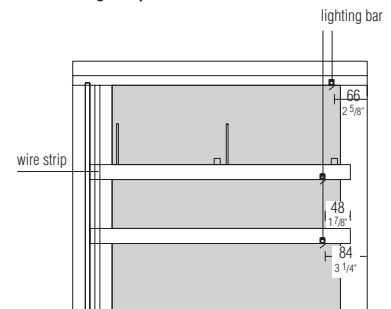

LIGHTING SYSTEM

System construction diagram

A composition (wardrobe) can be equipped with more than one system and more than one power supply unit. The system with sensor must be autonomous from the system with remote controlled electrical socket.

types of systems with sensors

system with sensor + wire strip suggested for wardrobes with doors

system with sensor (not for use with glass backs) suggested for wardrobes with doors and bars positioned only on the top piece

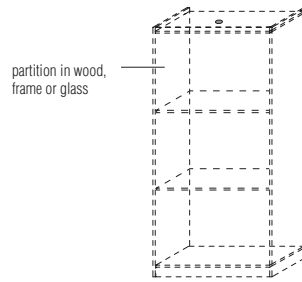
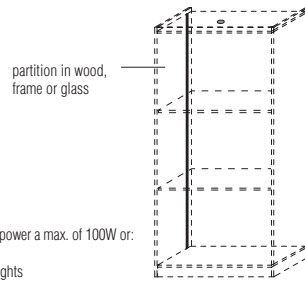

★ each power supply unit can power a max. of 100W or:
max 6 sensors
max 6 wire strip or 6 LED lights

sensor (1 per compartments)	●	●
power supply unit (per composition ★)	●	●
wire strips on lateral pieces (per compartment)	●	
connector (for compositions of 4 power supply units max.)	●	●

types of systems with remote control electrical socket or radio remote control

one radio remote control unit can control systems with 2 power supply units max. Otherwise, more radio remote control units must be used.

system with wire strip for remote control electrical socket suggested for wardrobes without doors (walk-in wardrobes) and glass doors

system with remote control electrical socket (not for use with glass backs) suggested for wardrobes without doors (walk-in wardrobes) and glass doors

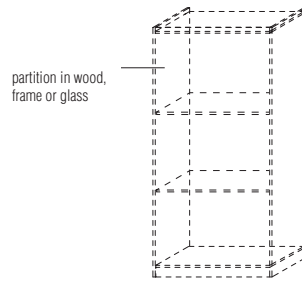
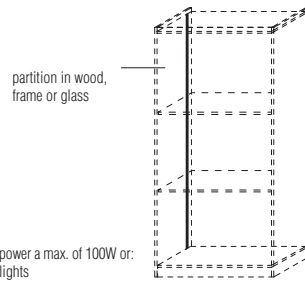

★ each power supply unit can power a max. of 100W or:
max 6 wire strips or 6 LED lights

power supply unit (per composition ★)	●	●
wire strips on lateral pieces (per compartment)	●	
connector (for compositions of 4 power supply units max.)	●	●
radio remote control (optional)	● (optional)	● (optional)

DALI kit (for DOMOTICA)

n. 1 for each power supply unit
cannot be used with
radio remote control

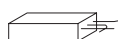

EKDA1

INTERNAL ACCESSORIES

Aircub is an air purifier and aroma diffuser that eliminates up to 95% of the harmful agents inside wardrobes through a process of ionisation and ozonation. Aircub can be managed easily from your smartphone with a dedicated app. Aircub can be installed on the back panel of each compartment. Just plug it into the electrical socket and turn it on. Every Aircub has a single plug.

Up to 3 Aircubs per wardrobe can be installed using the specific multi-socket connector.

Information about Aircub is available on the website <https://www.check-up.it> in the projects section.

Aircub - air purifier

W 270 D 28 H 120
W 10 5/8" D 1 1/8" H 4 3/4"
(cable length L3m)

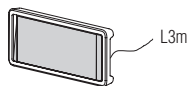

EAC1

product advantages

- improves air quality
 - reduces bacteria that cause foul odours
 - prevents mould and mites from forming
 - dispenses fragrance
 - does not have filters that require maintenance or changes
 - includes n.1 fragrance pod
- Scented wafers can be ordered online:
<https://shop.check-up.it/>

multi-socket connector

cable length 3m
W 250 D 60 H 40
W 9 7/8" D 2 3/8" H 1 5/8"

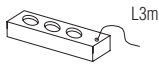

EAC2

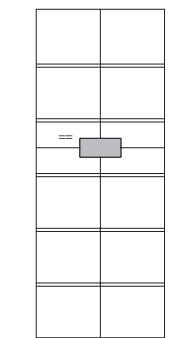
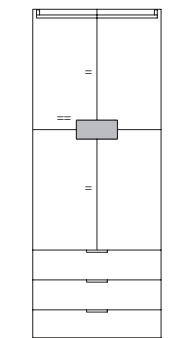

For correct function it is advisable to position the Aircub at the centre of the compartment

INTERNAL FITTINGS

Internal fittings
with wooden sides

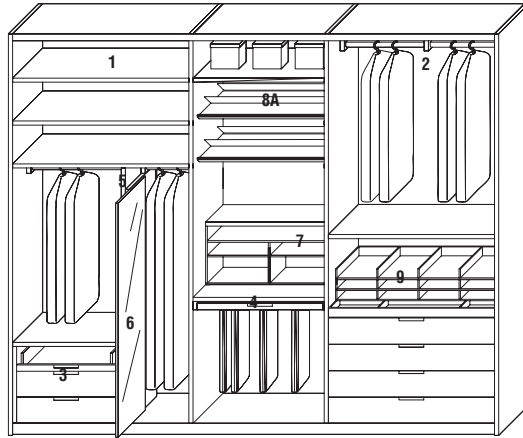

Internal fittings
with frame or glass sides

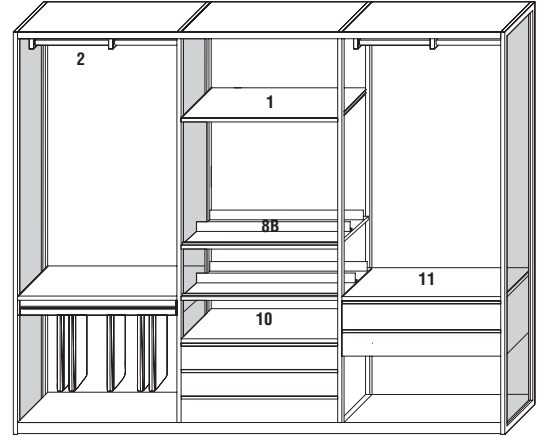

- 1** Shelf th 30 mm (wood, glass, Eco Skin)
- 2** Clothes rail
- 3** Modular drawer unit only for wooden sides and backs
- 4** Trousler holder
- 5** Central divider piece th mm 30 only for compart. with wooden sides and backs
- 6** Swivel pull-out mirror only for compart. with wooden sides and backs
- 7** Shirt and sweater holder grid only for wood sides and backs
- 8A** Inclined shoe rack shelf only for wooden sides and backs
- 8B** Horizontal shoe rack shelf only for frame sides, glass sides or glass back
- 9** Pull-out shirt holder only for wooden sides and backs
- 10** Floor standing drawer unit only for compart. with frame or glass sides
- 11** Suspended drawer unit only for compart. with frame or glass sides

Section of internal fittings

595 - 23 3/8"
575 - 22 5/8"
266-10 1/2"-309-12 1/8"

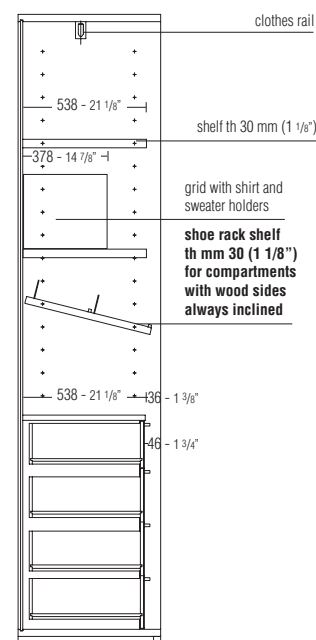

435 - 17 1/8" for use only with wooden sides

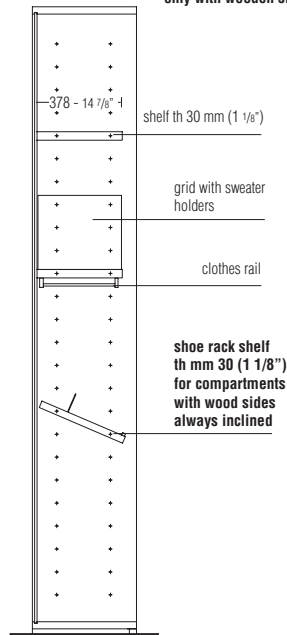

INTERNAL FITTINGS - SHELVES, SHOE RACK SHELVES

wood shelves - top shelves (only D 538)

D 538 th 30
D 378 th 30



W 298	W 380	W 462	W 626	W 790	W 954	W 1282
RI/3	RI/2	RI/4	RI/6	RI/8	RI/9	RI/13

shelf for external corner unit th 30

559x559
RIB/6

shelf for open corner element th 30

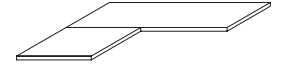

1081x1081	1262x1262
RIA/11	RIA/13

glass shelves can be fitted with front LED light bars and comply with the wiring standards

transparent glass shelves

D 538 th 30
D 378 th 30



W 380	W 462	W 626	W 790	W 954	W 1282
RV/2	RV/4	RV/6	RV/8	RV/9	RV/13

not for use in compartments adjacent to the corner element in wardrobes with doors

shelf for external corner unit th 30

559x559
RVB/6

38
49

Eco Skin shelves can be fitted with front LED light bars and comply with the wiring standards

Eco Skin shelves - shelves with Eco Skin cover (only D 538)

D 538 th 30
D 378 th 30



W 298	W 380	W 462	W 626	W 790	W 954	W 1282
RE/3	RE/2	RE/4	RE/6	RE/8	RE/9	RE/13

When ordering, specify the finish Eco Skin and profile

Eco Skin shelf for open corner element th 30

shelf for external corner unit th 30

559x559
REB/6

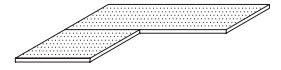

1081x1081	1262x1262
REA/11	REA/13

Shoe rack shelves

Shoe rack shelves can be used with wood sides and with frame or glass sides. When inserted between wood sides, this part will always be inclined (example 1). When there are frame or glass sides, this part will always be horizontal (example 2).

Notes

To hook to the frame or glass sides, add the price of the relative metal profiles.

example 1

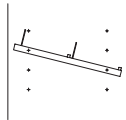

shoe rack shelves

D 538 th 30



W 462	W 626	W 790	W 954	W 1282
RSP/4	RSP/6	RSP/8	RSP/9	RSP/13

example 2

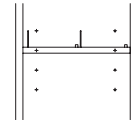

example 1

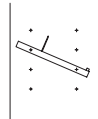

shoe rack shelves

D 368 th30



W 462	W 626	W 790	W 954	W 1282
RQP/4	RQP/6	RQP/8	RQP/9	RQP/13

metal profile for attaching shelves to frame side



PST

metal profile for attaching shelves to glass side



PSV

metal profile for attaching shelves with LEDs to frame side (always on the left, except in corner shelves)



PSE

INTERNAL FITTINGS - CLOTHES RAILS, HANGER RAILS, PULL-DOWN HANGERS, CENTRAL DIVIDER PIECES

clothes rails

									
W 298	W 380	W 462	W 626	for external corner unit	W 790	W 954	W 1282		
PO/3	PO/2	PO/4	PO/6	POB/6	PO/8	PO/9	PO/13		

clothes rail for corner compartment with doors

POA/6

clothes rail for D 435

to mount on wood shelves or top only with hinged doors

nr. 1 piece on compartment W 626/790
nr. 2 pieces on compartment W 954/1282

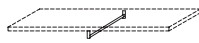

POQ/4

clothes rails for open corner compartment

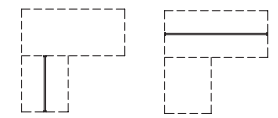

W 723
POA/7

W 1262
POA/13

pull-out coat hanger rail

for melamine shelf (without profile) th 30



OP7

hanger W 450

beech stained grey
(package of 10 pieces)



OP10

hanger with clips W 450

beech stained grey
(package of 3 pieces)



OP11

Maximum load-bearing capacity 10 kg

pull-down hanger

H mm 1040
for compart. W 626

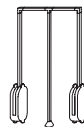

SER/6

for compart. W 790

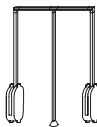

SER/8

for compart. W 954

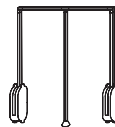

SER/9

for compart. W 1282

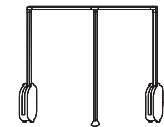

SER/13

When ordering, specify the finish of the front profile: pewter colour or bronze

floor standing central divider pieces

D 538 th 30

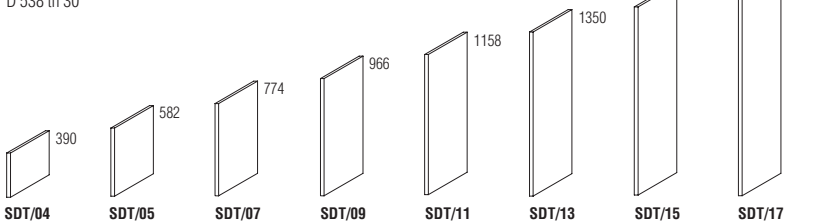

GLASS LID FOR CHEST OF DRAWERS

To be used only in compartments with wooden sides

Modular chests of drawers can be made with a transparent glass lid in the module widths 790/954/1282.

It is mandatory that the first drawer be H 190 in wood (special measure).

The top can be fitted with a LED lighting bar, but it cannot be connected to the cable holder.

The connection to the power cord has to pass behind the back panel.

Eco Skin bottoms in grey can be inserted.



W 790
CSV/08

W 954
CSV/09

W 1282
CSV/13

40—
49

Example of use

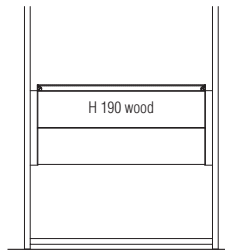

canvas-covered boxes
with Molteni logo

W 500 D 400 H 150
(package of 2 pieces)

W 500 D 400 H 300
(package of 2 pieces)



CES1



CES2

INTERNAL FITTINGS - MOVABLE TRAYS SET

Only for use in compartments with wooden sides

These units can be positioned on the floor-standing drawer units or suspended over a drawer H 190 of the same dimensions as the unit (see ex. 1).
The price of the blocks does not include the shelf covering the drawer unit.

Finishes

The trays are always made in melamine in the finish of the structure with bottom in grey Eco Skin.
The trinket tray is always dolomite lacquered.

example 1

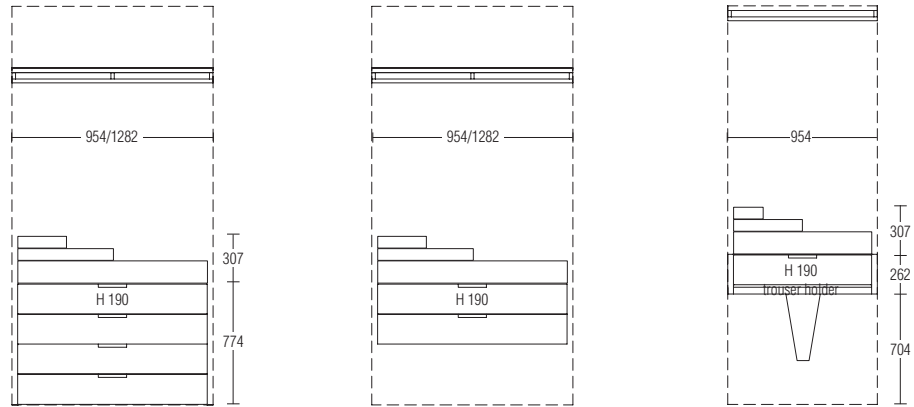

41 —
49

The price of the blocks does not include the shelf covering the drawer unit

for compartment
W 954

for compartment
W 1282

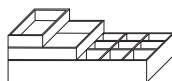

BVS9/03/1

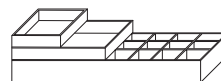

BVS13/03/1

INTERNAL FITTINGS - PULL-OUT SHIRT HOLDER - GRID WITH SHIRT AND SWEATER HOLDERS

Pull-out shirt holder only for use in compartments with wooden sides

These units can be positioned on the floor-standing drawer units or suspended over a drawer H 190 of the same dimensions as the shirt unit (see ex. 1).

Notes

Do not use for compartments with glass back.

Finishes

The tray set on top of the shelf is always finished in melamine in the same finish as the structure with Eco Skin bottom grey finish.
The shirt holder grid is always dolomite lacquered.

example

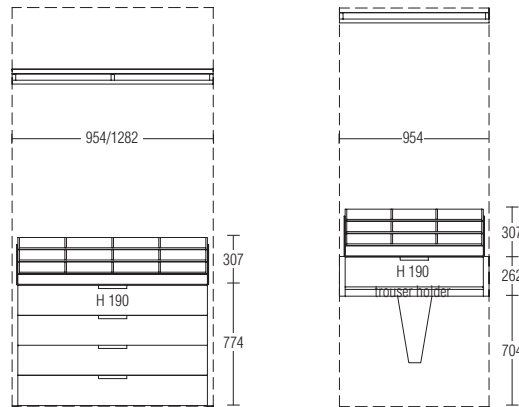

When ordering, specify the finishes of the trays set on shelves and the shirt holder grid

for compartment
W 954
including resting shelf

for compartment
W 1282
including resting shelf

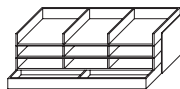

BPC9/03/1

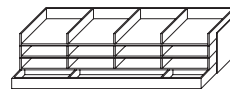

BPC13/03/1

Grid with shirt and sweater holders

These elements are fixed and to be used set on shelves or on drawer units.
Only in compartments with wood sides.

Grid with shirt and sweater holders

W 626 D 378 H 480

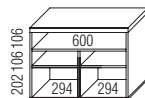

BGR6/05/1

W 790 D 378 H 480

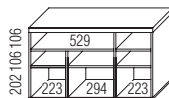

BGR8/05/1

W 954 D 378 H 480

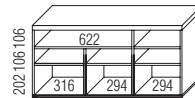

BGR9/05/1

W 1282 D 378 H 480

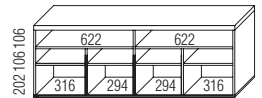

BGR13/05/1

Examples of use

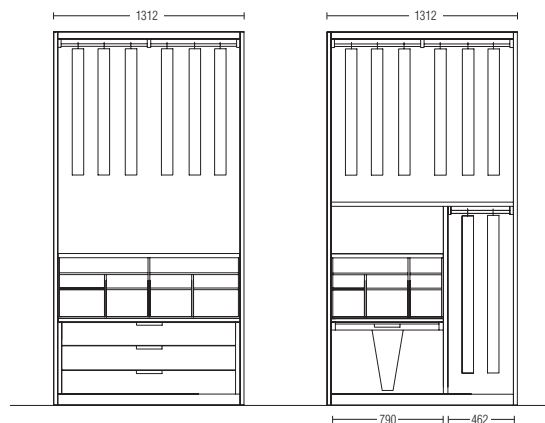

INTERNAL FITTINGS - MIRRORS

Procedure for using the swivel pull-out mirror

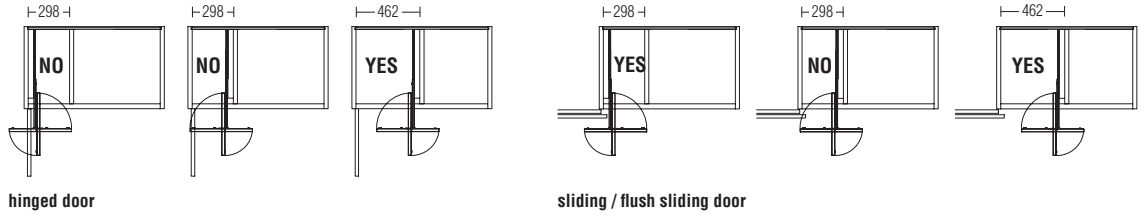

mirror
 applied to inside of
 hinged door
 W 315 H 1600 th 4

swivel pull-out mirror
 to be applied onto the side,
 partition or central divider pieces
 D 555 H 1443 th 90

43 —
 49



SPECH

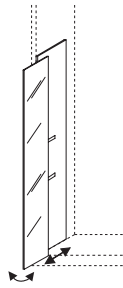

SPECS/17

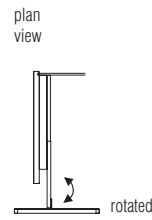

rotated

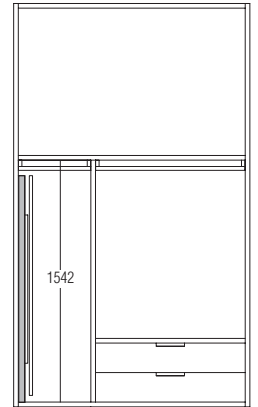
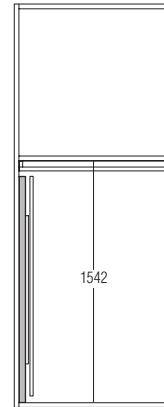

INTERNAL FITTINGS - MODULAR DRAWERS AND TRAYS

Notes

The parts of this internal fittings are produced with width and height dimensions corresponding to the modular compartments. This makes it possible to organise the internal spaces in a number of ways. To correctly and quickly determine the internal fittings, some of the possible compositions are in the following pages.

The pairs of side panels suspended or resting on the floor are essential for inserting all the elements.

Compositions must be completed with a top shelf.

When ordering, specify the handle finish as pewter colour or bronze.

No reductions of any kind can be made on drawers, trays and pairs of side panels.

Warnings on using compartments adjacent to the corner element

It is impossible to use trouser or trinket trays (used individually).

Wooden drawer finishes

melamine front in structure finish and piqué melamine
fine grain finish front with pewter colour or bronze profile

drawer inside in grey saffiano melamine

Glass drawer finishes

transparent glass front with pewter colour or bronze frame
inside in grey saffiano melamine

Open drawer finishes

melamine front in structure finish and piqué melamine
inside in grey saffiano melamine

Items available

Wooden drawers (melamine or fine grain)

STANDARD handle (pewter colour, bronze or Eco Skin finish)

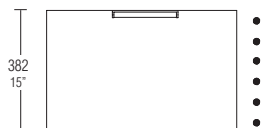
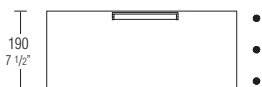

416 - 580 - 716 - 880 - 1208
16 3/8 - 22 7/8 - 28 1/4 - 34 5/8 - 47 1/2

HOLD handle (pewter colour or bronze finish)



416 - 580 - 716 - 880 - 1208
16 3/8 - 22 7/8 - 28 1/4 - 34 5/8 - 47 1/2

Glass drawers



416 - 580 - 716 - 880 - 1208
16 3/8 - 22 7/8 - 28 1/4 - 34 5/8 - 47 1/2



416 - 580 - 716 - 880 - 1208
16 3/8 - 22 7/8 - 28 1/4 - 34 5/8 - 47 1/2

Open drawers

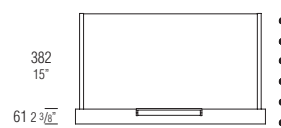
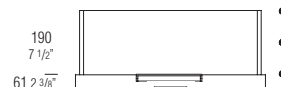

416 - 580 - 716 - 880 - 1208
16 3/8 - 22 7/8 - 28 1/4 - 34 5/8 - 47 1/2

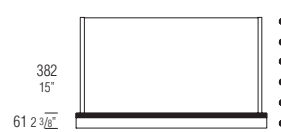

416 - 580 - 716 - 880 - 1208
16 3/8 - 22 7/8 - 28 1/4 - 34 5/8 - 47 1/2

INTERNAL FITTINGS - MODULAR DRAWERS AND TRAYS

Trouser holder finishes

melamine front in the same finish as the structure, piqué melamine or fine grain with pewter colour or bronze profile
inner frame in grey saffiano melamine with trouser holder in grey saffiano embossed

Trinket tray finishes

melamine front in the same finish as the structure, piqué melamine or fine grain with pewter colour or bronze profile
inner frame, bottom and grid in grey saffiano melamine

Pull-out trays finishes

melamine front in structure finish or piqué melamine with shelf and back in grey saffiano melamine

STANDARD handle (pewter colour, bronze or Eco Skin finish)

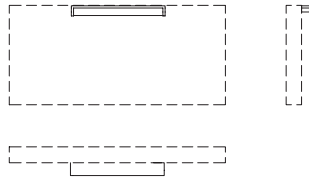

HOLD handle (pewter colour or bronze finish)



Notes

Prices of drawers, trays and pull-out trays include the cost of the pewter colour or bronze finish STANDARD handle. For the STANDARD handle covered in Eco Skin, add a supplementary charge for each.

Trouser holder

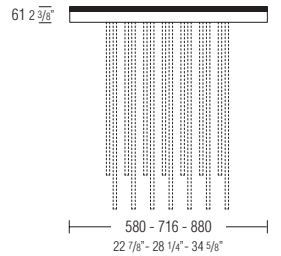
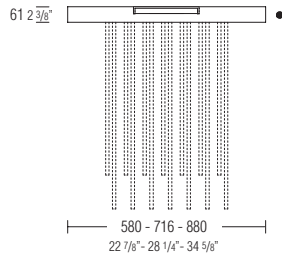

N.B.: usable only with suspended side panels as the bottom piece

Trinket trays (tie and belt) with internal grid

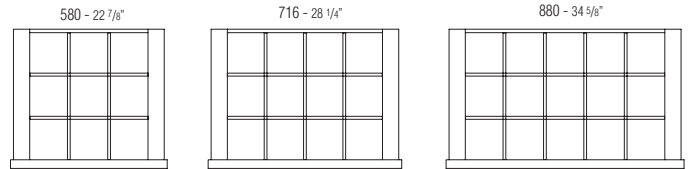
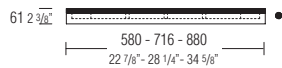
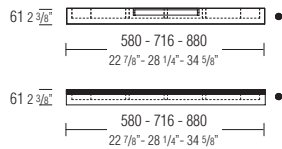

internal tray dividers

Pull-out trays

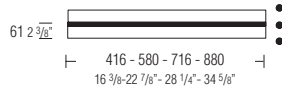
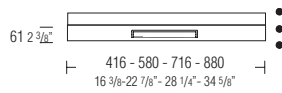

INTERNAL FITTINGS - ACCESSORIES FOR DRAWERS

Leather trays

Handmade leather trays with Alcantara bottom.
The version for men is brown (cat. P col. D533),
The version for women is powder pink (cat. P col. D524).

Eco Skin bottoms

Made with grey coloured Eco Skin.

leather trays men's drawers

W 206 D 430 H 58 (A)
W 206 D 215 H 58 (B)

watch holder
(A)

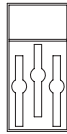

CEV/MA1

watch/
bracelet holder
(A)

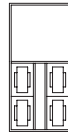

CEV/MA2

jewellery holder
with movable dividers
(B)



CEV/MB1

complete men's
drawer offer

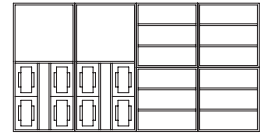

CVM1

leather trays women's drawers

W 206 D 430 H 58 (A)
W 206 D 215 H 58 (B)

watch holder
(A)

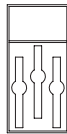

CEV/WA1

watch/
bracelet holder
(A)

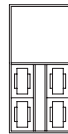

CEV/WA2

jewellery holder
with movable dividers
(B)



CEV/WB1

ring holder
(B)



CEV/WB2

earring holder
(B)



CEV/WB3

complete women's
drawer offer

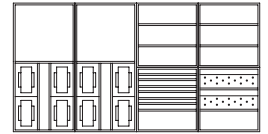

CVW1

Modularity drawings for inserting trays into drawers

drawer W 416

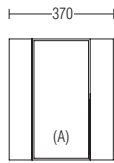

1 tray (A)
or 2 trays (B)

drawer W 580

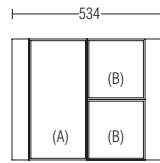

2 trays (A)
or 4 trays (B)

drawer W 716

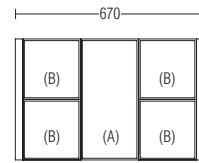

3 trays (A)
or 6 trays (B)

drawer W 880

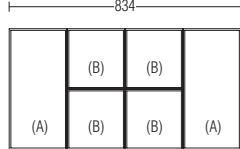

4 trays (A)
or 8 trays (B)

drawer W 1208

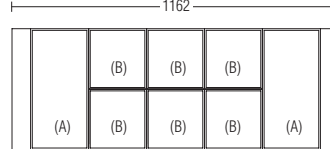

5 trays (A)
or 10 trays (B)

Eco Skin bottoms for drawers

D 432/473 special for 1st drawer with glass lid



W 366
CEQ/F4

W 530
CEQ/F6

W 666
CEQ/F8

W 830
CEQ/F9

W 1158
CEQ/F13

ISLAND DRAWER UNIT - DRAWER UNIT

Island drawer unit

Made completely in larix dark or silver cembran melamine and available in two versions: with or without trinket trays in dolomite lacquer. Shelves in Eco Skin are available in colours in the catalogue. Standard handles are mounted, in pewter colour or bronze finish. It is possible to make STANDARD handles covered in Eco Skin with a supplemental charge for each.

version with trinket trays

- Side A has 6 drawers H 190 and 2 extractable trinket tray blocks.
- Side B has 4 drawers H 190 and and lower open compartments.

version without trinket trays

- Side A has 6 drawers H 190 and upper open compartment.
- Side B has 4 drawers H 190 and and lower open compartments.

Dimensions of the island cannot be reduced, and the composition cannot be modified.

It is possible to substitute the melamine drawers with glass drawers by adding the difference in price from **CLN8/19** and **CVN8/19**.

It is possible to substitute the melamine drawers with drawers with fine grain fronts by adding the difference in price of the finishes of the code **CLN8/19**.

47—
49

island drawer unit with trinket trays

W 1518 D 1022 H 897
W 59 3/4" D 40 1/4" H 35 3/8"

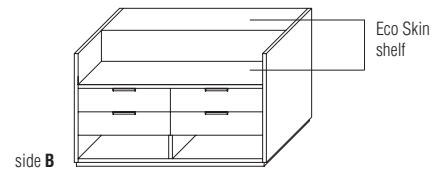
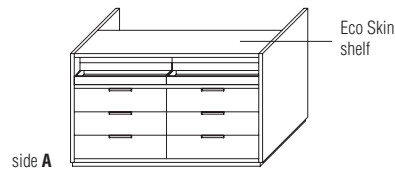

larix dark/silver cembran:
STANDARD handle
HOLD handle

ISC15/09/1

island drawer unit without trinket trays

W 1518 D 1022 H 897
W 59 3/4" D 40 1/4" H 35 3/8"

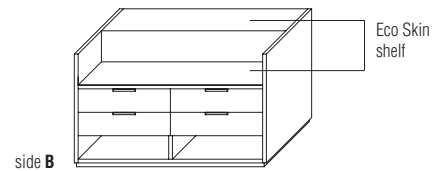
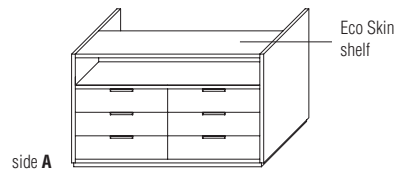

larix dark/silver cembran:
STANDARD handle
HOLD handle

ISC15/09/2

Drawer unit

Made in larix dark, silver cembran or matt lacquer in Molteni range colours. Standard handles are mounted, in pewter colour finish.

It is possible to make STANDARD handles covered in Eco Skin with a supplemental charge for each.

drawer unit

W 1292 D 527 H 897
W 50 7/8" D 20 3/4" H 35 3/8"

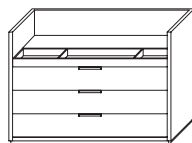

STANDARD handle HOLD handle
ISC13/09/1

ISLAND WITH TRANSPARENT GLASS DOORS

Island that can be created with structure in transparent glass and horizontal parts in wood. Shelves are in wood except for those indicated (*) which are always in glass.

The island cannot be reduced or modified with respect to the versions in the price list.

Structure finish

pewter colour
bronze

Base unit / top / shelf finishes

eucalyptus
graphite oak

H 880 - 34 5/8"
with top
D 1000 - 39 3/8"

W 1673 - 65 7/8"

W 2001 - 78 3/4"

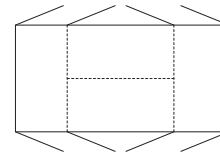
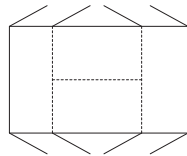
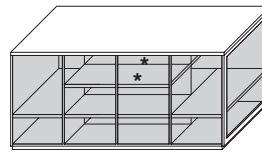
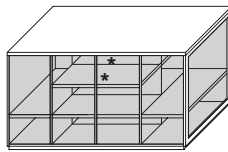

ISV16/08

ISV20/08

without LEDs
with LEDs

The island is available with or without LED lighting applied on all shelves and tops as shown. The system includes the cable holders and power supply units that enable it to work with a remote control.

front

back

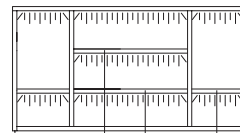
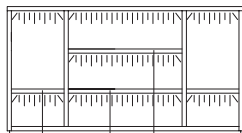

*
glass
shelves
wood
shelves

ISLAND WITH GLASS TOP

- Handle HOLD for drawers
- The drawer front are always made of silver cembran or larix dark melamine
- Partition grids can only be inserted in the upper drawer

Island finishes

silver cembran
larix dark

Handles / top profile finishes

pewter colour
bronze

No reductions of any kind are possible

49 —
49

island with glass top

W 1498 D 1022 H 864
W 59" D 40 1/4" H 34"

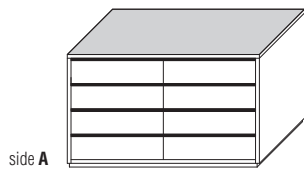

ISW15/09/3

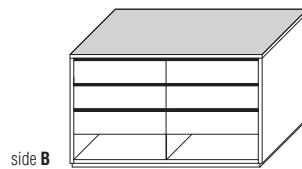

accessories for upper drawer

partition grid

grey saffiano
W 666 D 443
W 26 1/4" D 17 1/2"

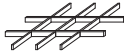

Eco Skin bottom

grey
W 666 D 443
W 26 1/4" D 17 1/2"

