

SC16

2016



+ info: <https://www.depadova.com/materials.pdf>
De Padova srl - info@depadova.it

CABINET

Materials

Carcass

blockboard panels veneered in Fossil oak or smoked oak, finished with transparent coating. 45° edges in solid Fossil oak or smoked oak.

Drawers

blockboard, veneered in Fossil oak or smoked oak, finished with transparent coating. Installed on runners with soft-close system.

Drawer fronts

blockboard, veneered in Fossil oak or smoked oak, finished with transparent coating. Or in sheet in striped DeLabré G7 brass, striped DeLabré 7022 F12 stainless steel or DeLabré B E5 stainless steel. 45° edge and handle in solid wood.

Top

blockboard, veneered in Fossil oak or smoked oak, finished with transparent coating. Or interior structural aluminium panel covered by sheet in striped DeLabré G7 brass, striped DeLabré 7022 F12 stainless steel or DeLabré B E5 stainless steel. Or in hand-finished marble treated with water-repellent products or finished with matt polyester. Or in MDI composite.

Base

matt black powder-coated steel and feet in painted steel with burnished effect. Adjustable thermoplastic glide foot.

Feet

burnished painted steel. Adjustable thermoplastic glide foot.

SC16

2016

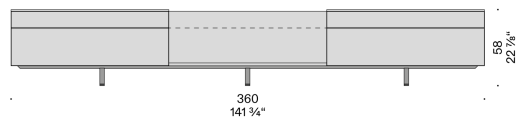
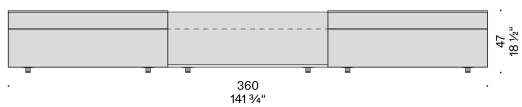
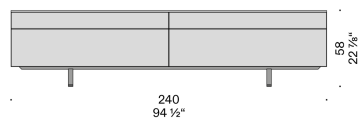
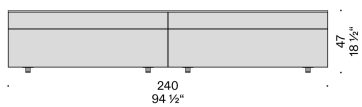
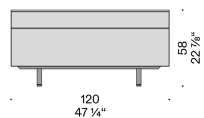
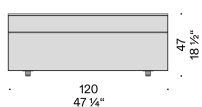
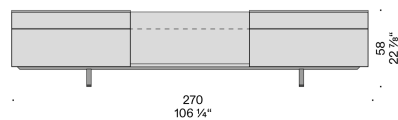
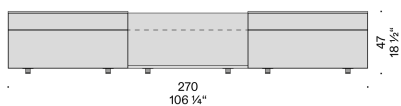
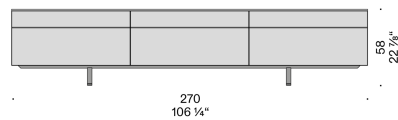
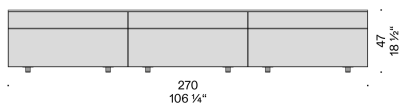
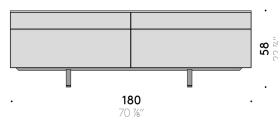
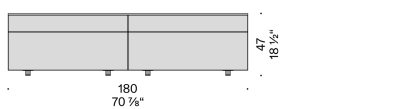
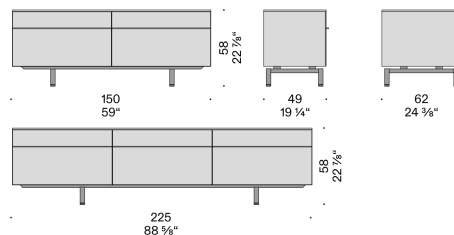
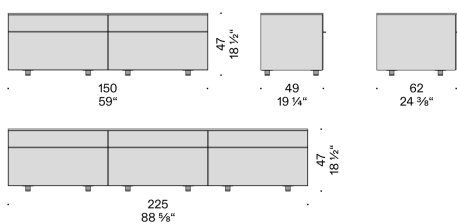

SC16

2016



+ info: <https://www.depadova.com/materials.pdf>
De Padova srl - info@depadova.it

CONTENITORE

Materiali

Struttura contenitore

pannelli di listellare impiallacciati in Fossil oak o rovere affumicato, finiti con vernice trasparente. Bordo a 45° in legno massello di Fossil oak o rovere affumicato.

Cassetti

listellare impiallacciato in Fossil oak o rovere affumicato, finiti con vernice trasparente, montati su guide con meccanismo di ammortizzazione.

Frontali cassetti

listellare impiallacciato in Fossil oak o rovere affumicato, finiti con vernice trasparente. Oppure in lamiera in Ottone DeLabré striato G7, Acciaio inox DeLabré striato 7022 F12 o Acciaio inox DeLabré B E5. Bordo a 45° e maniglia in massello di essenza.

Piano superiore

listellare impiallacciato con Fossil oak o rovere affumicato, finiti con vernice trasparente. Oppure pannello interno in alluminio strutturale rivestito con lamiera in Ottone DeLabré striato G7, Acciaio inox DeLabré striato 7022 F12 o Acciaio inox DeLabré B E5. Oppure marmo finito a mano e trattato con prodotti idrorepellenti o finito con poliestere opaco. Oppure composito MDI.

Basamento

acciaio verniciato a polvere nero opaco e piede in acciaio verniciato effetto brunito. Sottopiede regolabile in termoplastica.

Piedini

acciaio verniciato brunito. Sottopiede regolabile in termoplastica.

SC16

2016

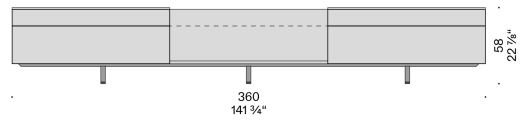
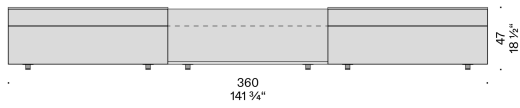
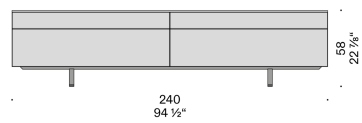
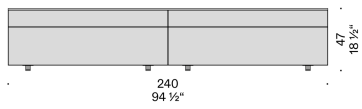
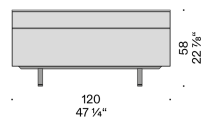
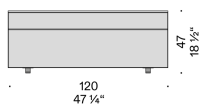
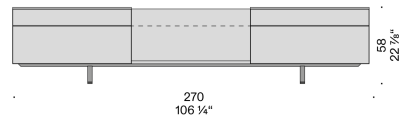
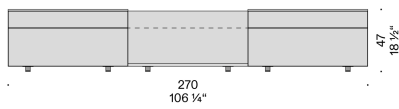
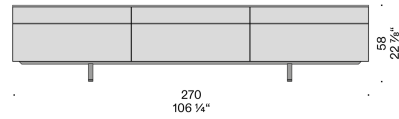
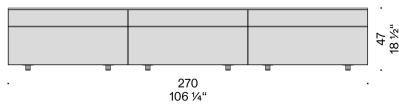
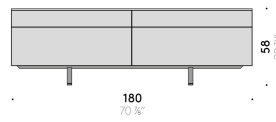
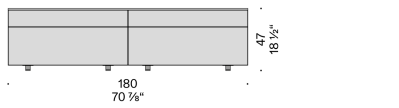
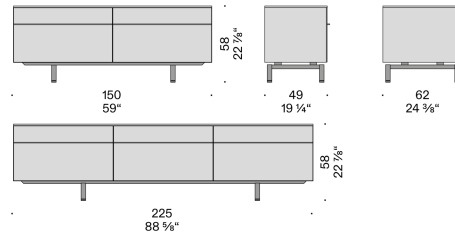
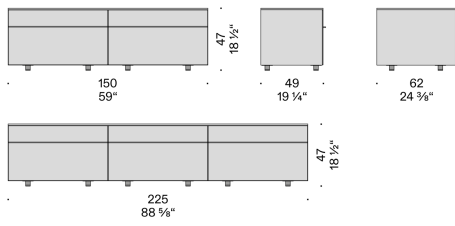

SC16

2016



+ info: <https://www.depadova.com/materials.pdf>
De Padova srl - info@depadova.it

ÉLÉMENT DE RANGEMENT

Matériaux

Structure élément de rangement
panneaux de latté plaqués en Fossil oak ou chêne fumé, finis avec peinture transparente. Bord à 45° en bois massif de Fossil oak ou chêne fumé.

Tiroirs

latté plaqué en Fossil oak ou chêne fumé, finis avec peinture transparente, montés sur glissières avec mécanisme d'amortissement.

Façades tiroirs

panneau de latté plaqué en Fossil oak ou en chêne fumé, fini avec peinture transparente. Ou panneau avec tôle en Laiton DeLabré strié G7, Acier inox DeLabré strié 7022 F12 ou Acier inox DeLabré B E5. Bord à 45° et poignée en massif d'essence.

Dessus supérieur

panneau de latté plaqué en Fossil oak ou en chêne fumé, fini avec peinture transparente. Ou panneau intérieur en aluminium structurel revêtu de tôle en Laiton DeLabré strié G7, Acier inoxydable DeLabré strié 7022 F12 ou en Acier Inox DeLabré B E5. Ou marbre fini à la main et traité avec des produits hydrofuges ou fini avec du polyester mat. Ou composite MDI.

Embase

acier peint à poudre noir mat et pied en acier peint avec effet bruni. Patin réglable en thermoplastique.

Pieds

acier peint bruni. Patin réglable en thermoplastique.

SC16

2016

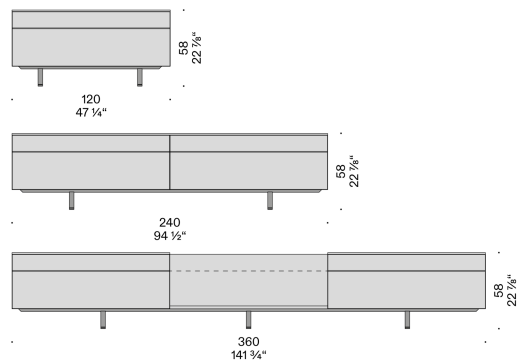
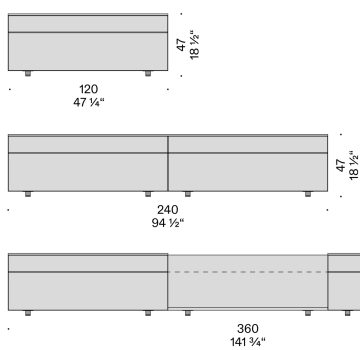
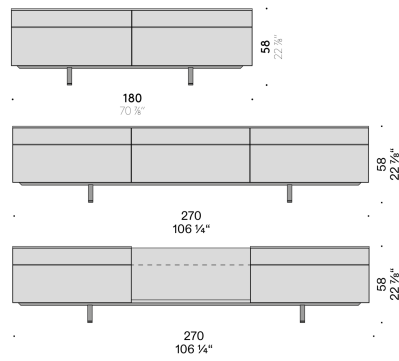
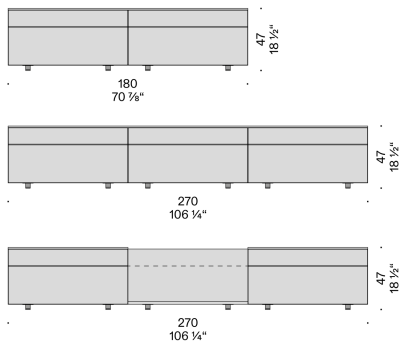
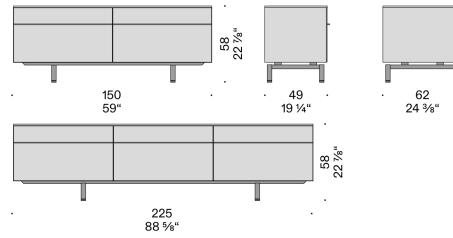
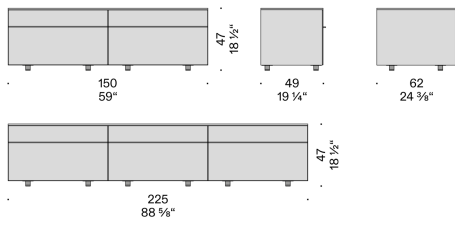

SC16

2016



+ info: <https://www.depadova.com/materials.pdf>
De Padova srl - info@depadova.it

SCHRANKELEMENT

Materialien

Korpus

Tischlerplatten, furniert in Fossil oak oder Räumereiche, endbehandelt mit transparentem Lack. Ecke 45° aus Massivholz Fossil oak oder Räumereiche.

Schubladen

Tischlerplatte, furniert in Fossil oak oder Räumereiche, endbehandelt mit transparentem Lack. Montiert auf Führungsschienen mit Einzugsdämpfer.

Schubladenfronten

Tischlerplatten, furniert in Fossil oak oder Räumereiche, endbehandelt mit transparentem Lack. Oder hergestellt aus Blech in Messing gestreift DeLabré G7, Edelstahl gestreift DeLabré 7022 F12 oder Edelstahl DeLabré B E5. Ecke 45° und Griffe aus Massivholz.

Oberplatte

Tischlerplatte, furniert in Fossil Oak oder Räumereiche, endbehandelt mit transparentem Lack. Oder Innenpaneel in Strukturaluminium verkleidet mit Blech in Messing gestreift DeLabré G7, Edelstahl gestreift DeLabré 7022 F12 oder Edelstahl DeLabré B E5. Oder handgefertigter Marmor, der mit wasserabweisenden Produkten behandelt oder mit mattem Polyester beschichtet wurde. Oder Verbundmaterial MDI.

Untergestell

Pulverlackiertes Stahlgestell mattschwarz und Fuß aus lackiertem Stahl mit brüniertem Effekt. Verstellbarer Thermoplast-Gleitfuß.

Füße

aus brüniertem lackiertem Stahl. Verstellbarer Thermoplast-Gleitfuß.

SC16

2016

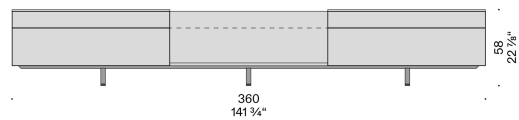
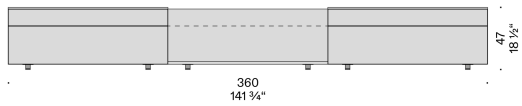
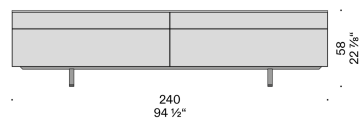
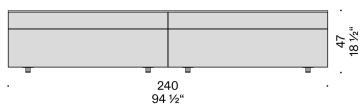
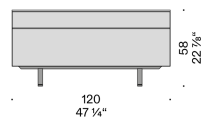
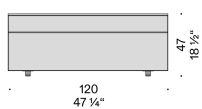
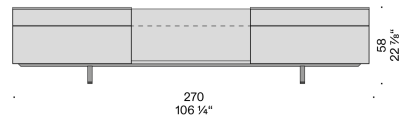
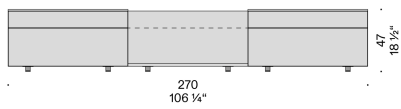
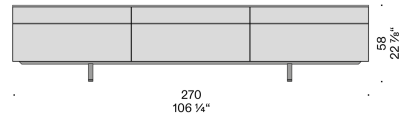
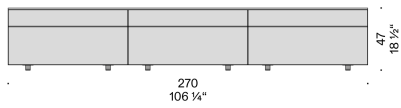
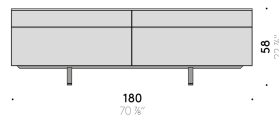
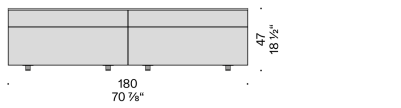
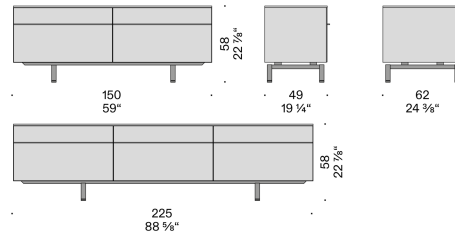
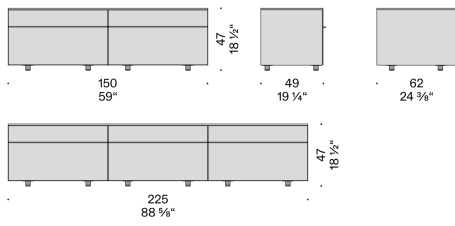

SC16

2016



+ info: <https://www.depadova.com/materials.pdf>
De Padova srl - info@depadova.it

MUEBLE CONTENEDOR

Materiales

Estructura mueble contenedor

paneles de madera alistonada chapados en Fossil oak o roble ahumado, acabados con pintura transparente. Borde en 45° de madera maciza de Fossil oak o roble ahumado.

Cajones

madera alistonada de Fossil oak o roble ahumado, acabados con barniz transparente, montados sobre guías con mecanismo de amortiguación.

Frentes cajones

madera alistonada chapada con Fossil oak o roble ahumado, acabados con pintura transparente. O con chapa de Latón DeLabré estriado G7, Acero inoxidable DeLabré estriado 7022 F12 o Acero inoxidable DeLabré B E5. Borde en 45° y tirador de madera maciza.

Tablero superior

madera alistonada chapada con Fossil oak o roble ahumado, acabados con pintura transparente. O panel interior de aluminio estructural recubierto con chapa de latón DeLabré estriado G7, Acero inoxidable DeLabré estriado 7022 F12 o Acero inoxidable DeLabré B E5. O marmol acabado a mano y tratado con productos repelentes al agua o acabado con poliéster mate. O compuesto MDI.

Base

acero pintado en polvo negro mate y pie de acero pintado efecto bruñido. Bajo-pie ajustable de termoplástico.

Pies

acero pintado bruñido. Bajo-pie ajustable de termoplástico.

SC16

2016

