

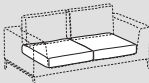

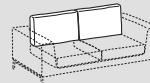

Avenue

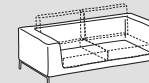
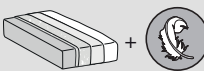

	 Seduta - Seat	 Schienali - Backrests	 Struttura - Structure	
Rivestimento Upholstering (10)	Sfoderabile Removable Non sfoderabile Not removable	Sfoderabile Removable Non sfoderabile Not removable	Sfoderabile Removable Non sfoderabile Not removable	
Imbottiture Padding (4-5-6-7-8-9)	 D.40kg/m³	 Misto piuma	 Pol.espanso	 Optional

INFORMAZIONI TECNICHE

Struttura: 1-2

Masselli portanti in legno di abete. Elementi strutturali in pannelli di legno multistrati in classe E1 con barre di rinforzo in metallo, tamponamenti in faesite.

Molleggio: 1-3

Schienale in pannello di faesite. Seduta in nastri elastici di fibra propilenica e lattice incrociati e meccanicamente pretensionati.

Note:

Piano per tavolino in pannelli di particelle di legno in classe E1 con parte inferiore rivestita in tessuto gommato antiscivolo.

TECHNICAL INFORMATION

Structure: 1-2

Solid bearing fir wood. Structural elements in plywood panels in class E1 with metal reinforcement bars, faesite infill.

Springing: 1-3

The back is made of hardboard panels. Seat with pre-tensioned crossed propylene fibre and latex elastic webbing.

Note:

Table top in wood particle board in class E1 with lower part covered in anti-slip rubberized fabric.

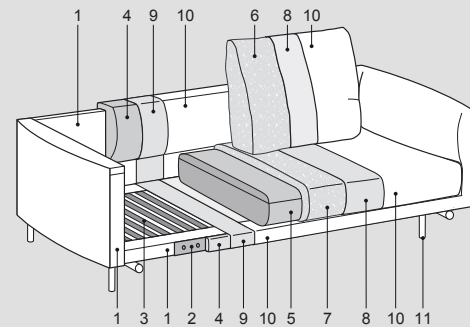
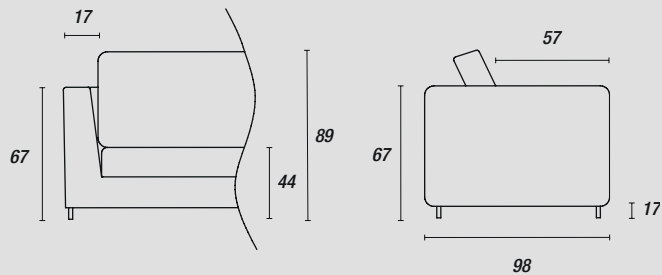

Piedini - Feet:



di serie AGO
H.17cm
Nero opaco (ME09)
con puntale nero lucido
Light brown (ME11)
con puntale inox

Accessori - Accessories:

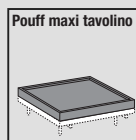

Grey wood (LE12)

Avenue light



	Seduta - Seat	Schienali - Backrests	Struttura - Structure	
Rivestimento Upholstering (10)	Sfoderabile Removable Non sfoderabile Not removable	Fabric	Fabric	Fabric
Imbottiture Padding (4-5-6-7-8-9)	D.40kg/m ³	Misto piuma	Pol.espanso + Tecnoform	ECOSY ETHICALLY SOFT MADE Optional

INFORMAZIONI TECNICHE

Struttura: 1

Masselli portanti in legno di abete. Elementi strutturali in pannelli di legno multistrati in classe E1 con barre di rinforzo in metallo, tamponamenti in faesite.

Molleggio: 1-4

Schienale in pannello di faesite. Seduta in nastri elastici di fibra propilenica e lattice incrociati e meccanicamente pretensionati.

Note:

Rivestimento non disponibile nei seguenti tessuti: Lewis, Like, Lolita, Meghan, Pablo, Peggy, Princess, Texas, Travel, Uniform, Unique.
Piano per tavolino in pannelli di particelle di legno in classe E1 con parte inferiore rivestita in tessuto gommato antiscivolo.

TECHNICAL INFORMATION

Structure: 1

Solid bearing fir wood. Structural elements in plywood panels in class E1 with metal reinforcement bars, faesite infill.

Springing: 1-4

The back is made of hardboard panels. Seat with pre-tensioned crossed propylene fibre and latex elastic webbing.

Note:

Upholstering not available in the following fabrics: Lewis, Like, Lolita, Meghan, Pablo, Peggy, Princess, Texas, Travel, Uniform, Unique.
Table top in wood particle board in class E1 with lower part covered in anti-slip rubberized fabric.

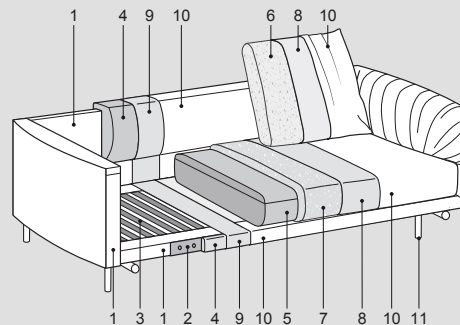
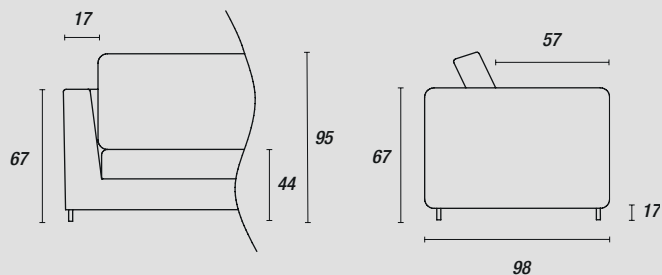

Piedini - Feet:



Accessori - Accessories:

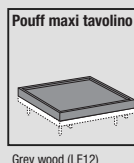

Avenue luxury



	Seduta - Seat	Schienali - Backrests	Struttura - Structure	
Rivestimento Upholstering (10)	Sfoderabile Removable Non sfoderabile Not removable	Fabric	Fabric	Fabric
Imbottiture Padding (4-5-6-7-8-9)	D.40kg/m³	Misto piuma	Pol.espanso + Tecnoform	ECOSY ETHICALLY SOFT MADE Optional

INFORMAZIONI TECNICHE

Struttura: 1

Masselli portanti in legno di abete. Elementi strutturali in pannelli di legno multistrati in classe E1 con barre di rinforzo in metallo, tamponamenti in faesite.

Molleggio: 1-4

Schienale in pannello di faesite. Seduta in nastri elastici di fibra propilenica e lattice incrociati e meccanicamente pretensionati.

Note:

Rivestimento non disponibile nei seguenti tessuti: Lewis, Like, Lolita, Meghan, Pablo, Peggy, Princess, Texas, Travel, Uniform, Unique.

I cuscini schienale hanno un lato plissettato (luxury) e un lato liscio.

Piano per tavolino in pannelli di particelle di legno in classe E1 con parte inferiore rivestita in tessuto gommato antiscivolo.

TECHNICAL INFORMATION

Structure: 1

Solid bearing fir wood. Structural elements in plywood panels in class E1 with metal reinforcement bars, faesite infill.

Springing: 1-4

The back is made of hardboard panels.

Seat with pre-tensioned crossed propylene fibre and latex elastic webbing.

Note:

Upholstering not available in the following fabrics: Lewis, Like, Lolita, Meghan, Pablo, Peggy, Princess, Texas, Travel, Uniform, Unique.

The back cushions have a pleated side (luxury) and a smooth side.

Table top in wood particle board in class E1 with lower part covered in anti-slip rubberized fabric.

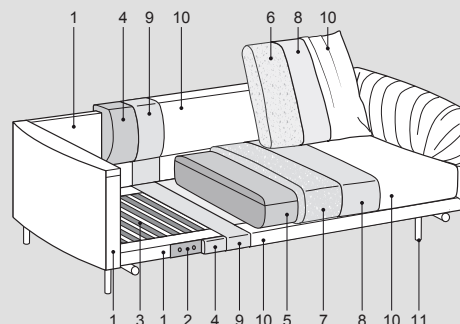
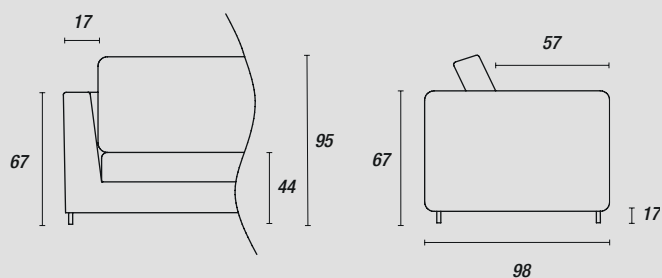

Piedini - Feet:



di serie AGO
H.17cm
Nero opaco (ME09)
con puntale nero lucido
Light brown (ME11)
con puntale inox



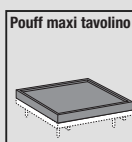





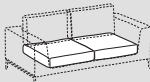
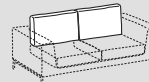
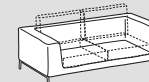

Accessori - Accessories:

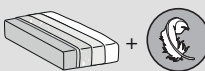

Grey wood (LE12)

Avenue soft



	 Seduta - Seat	 Schienali - Backrests	 Struttura - Structure	
Rivestimento Upholstering (10)	Sfoderabile Removable  	Sfoderabile Removable  	Sfoderabile Removable  	
	Non sfoderabile Not removable -	Non sfoderabile Not removable -	Non sfoderabile Not removable -	
Imbottiture Padding (4-5-6-7-8-9)	 D.40kg/m³	 Misto piuma	 Pol.espanso	 Optional

INFORMAZIONI TECNICHE

Struttura: 1

Masselli portanti in legno di abete. Elementi strutturali in pannelli di legno multistrati in classe E1 con barre di rinforzo in metallo, tamponamenti in faesite.

Molleggio: 1-2

Schienale in pannello di faesite. Seduta in nastri elastici di fibra propilenica e lattice incrociati e meccanicamente pretensionati.

Note:

Bracciolo a tavolino in metallo rivestito in rigenerato di cuoio, la cucitura e' sempre in tinta.

TECHNICAL INFORMATION

Structure: 1

Solid bearing fir wood. Structural elements in plywood panels in class E1 with metal reinforcement bars, faesite infill.

Springing: 1-2

The back is made of hardboard panels. Seat with pre-tensioned crossed propylene fibre and latex elastic webbing.

Note:

Armrest table in metal covered in bonded leather, the stitching is always matching.

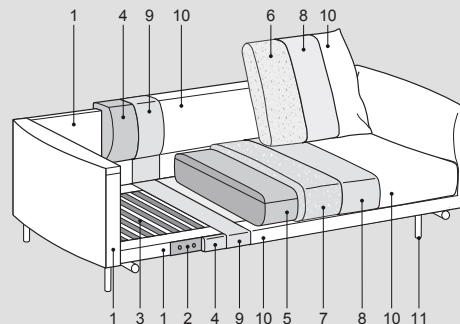
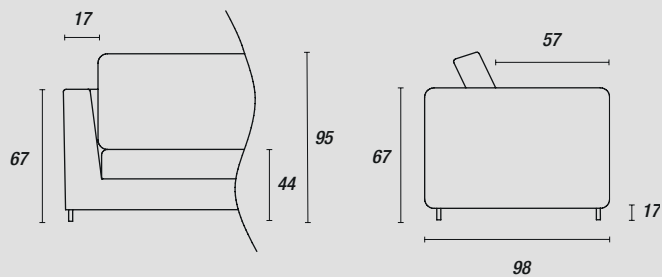

Piedini - Feet:



Nero opaco (ME09)
con puntale nero lucido

Light brown (ME11)
con puntale inox

Accessori - Accessories:

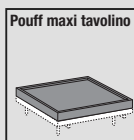

Grey wood (LE12)