

SOVET

ITALIA



Deod

collection booklet

collection booklet

Deod

Design **Gianluigi Landoni**

“
A new table whose shapes and materials are enhanced in a natural equilibrium of geometries thanks to the iconic base inspired by the sculpted lines of the Dolomites.

Un nuovo tavolo dove forme e materiali vengono esaltati in un naturale equilibrio di geometrie grazie all'iconica base ispirata alle caratteristiche linee scolpite delle Dolomiti.

”

Models & Dimensions

**Tavolo con base in metallo verniciato, disponibile in varie finiture.
Top temperato o stratificato in varie misure, materiali e finiture.**

Dining table with lacquered metal base, various finishes.
Tempered or laminated top in different measures, materials and finishes.

round

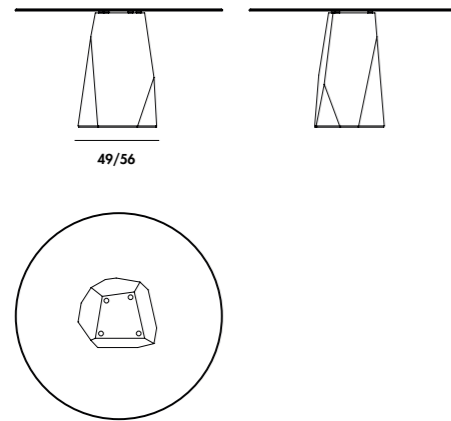

Ø100x75h
Ø120x75h
Ø130x75h
Ø140x75h
Ø150x75h
Ø170x75h

two bases

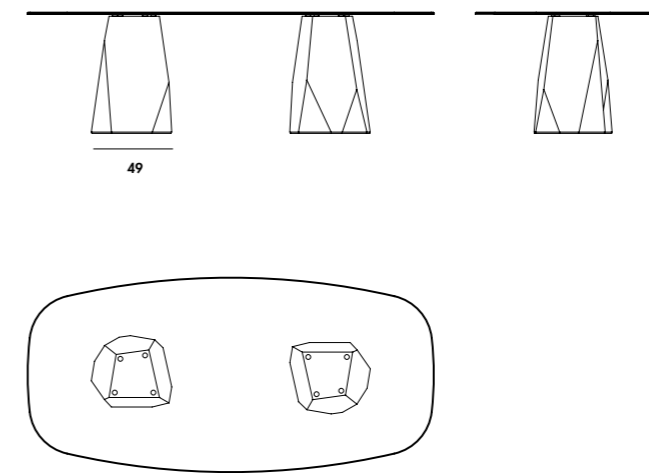

220x115x75h
250x120x75h
300x135x75h

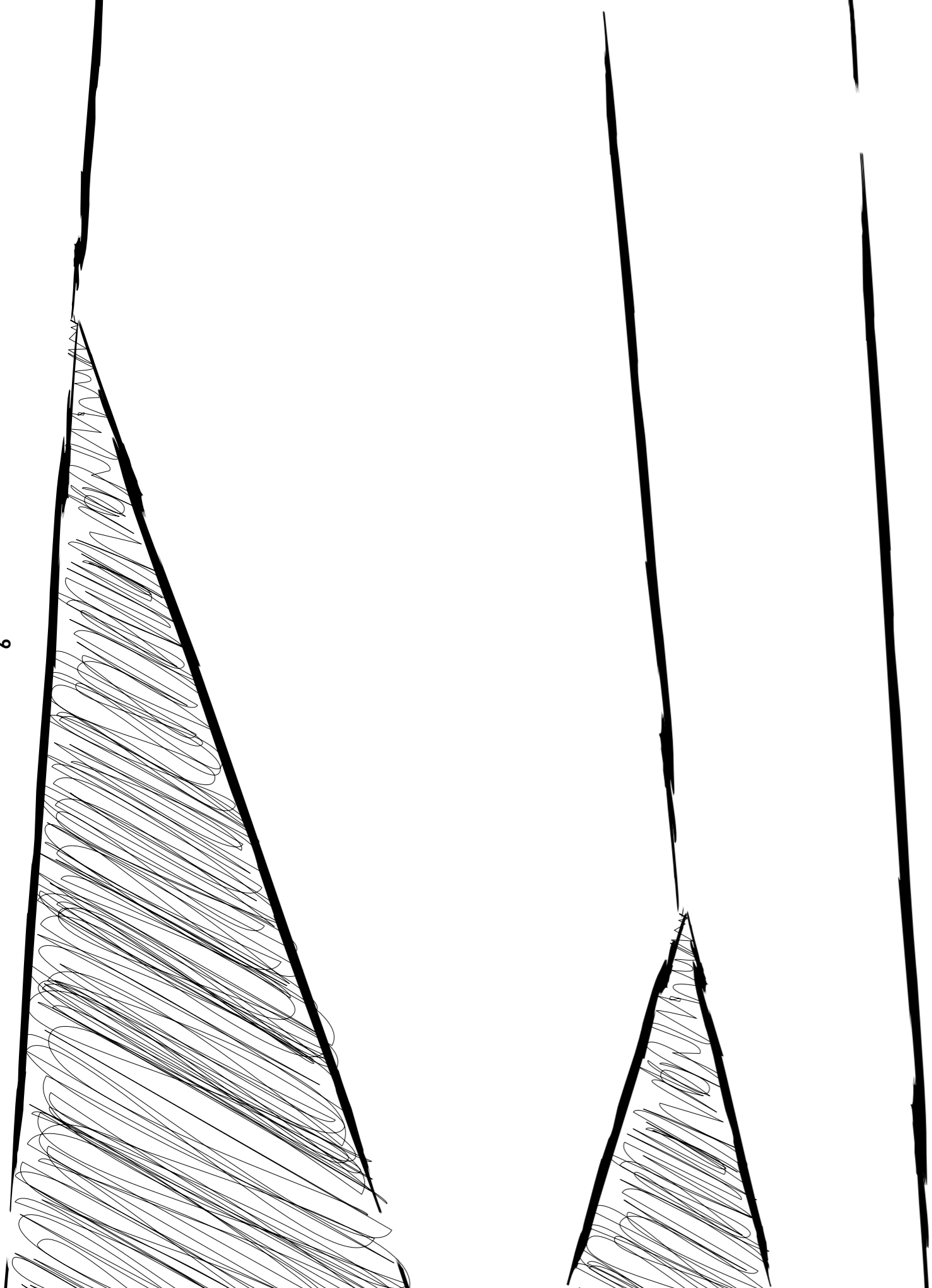

A new table whose shapes and materials are enhanced in a natural equilibrium of geometries thanks to the iconic base inspired by the sculptured rocks of the Dolomites.

Un nuovo tavolo dove forme e materiali vengono esaltati in un naturale equilibrio di geometrie, grazie all'iconica base ispirata alle caratteristiche linee scolpite delle Dolomiti.

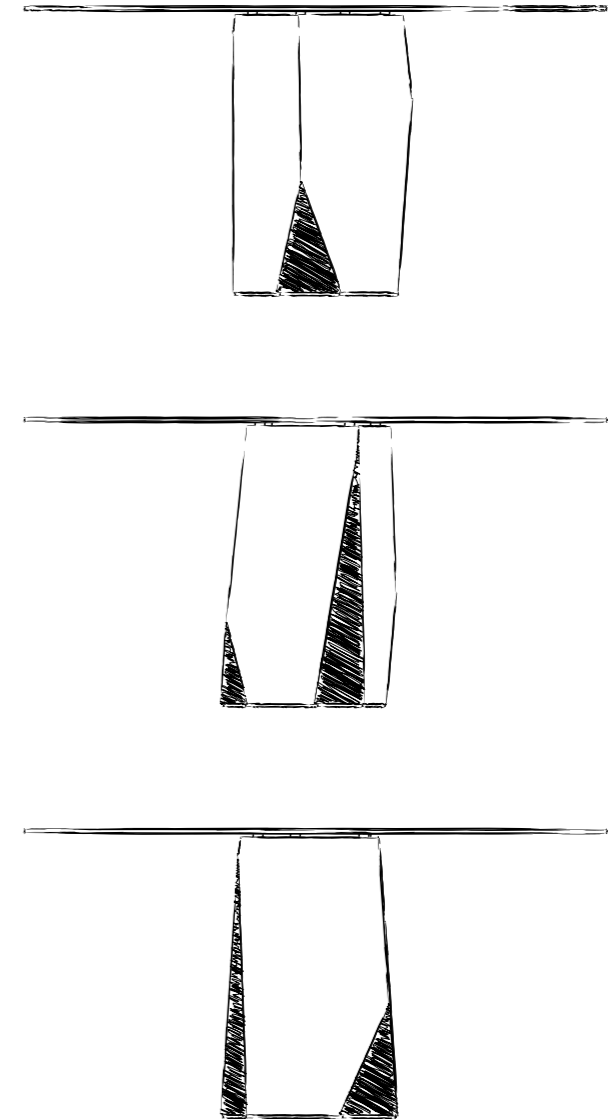

collection
finishes

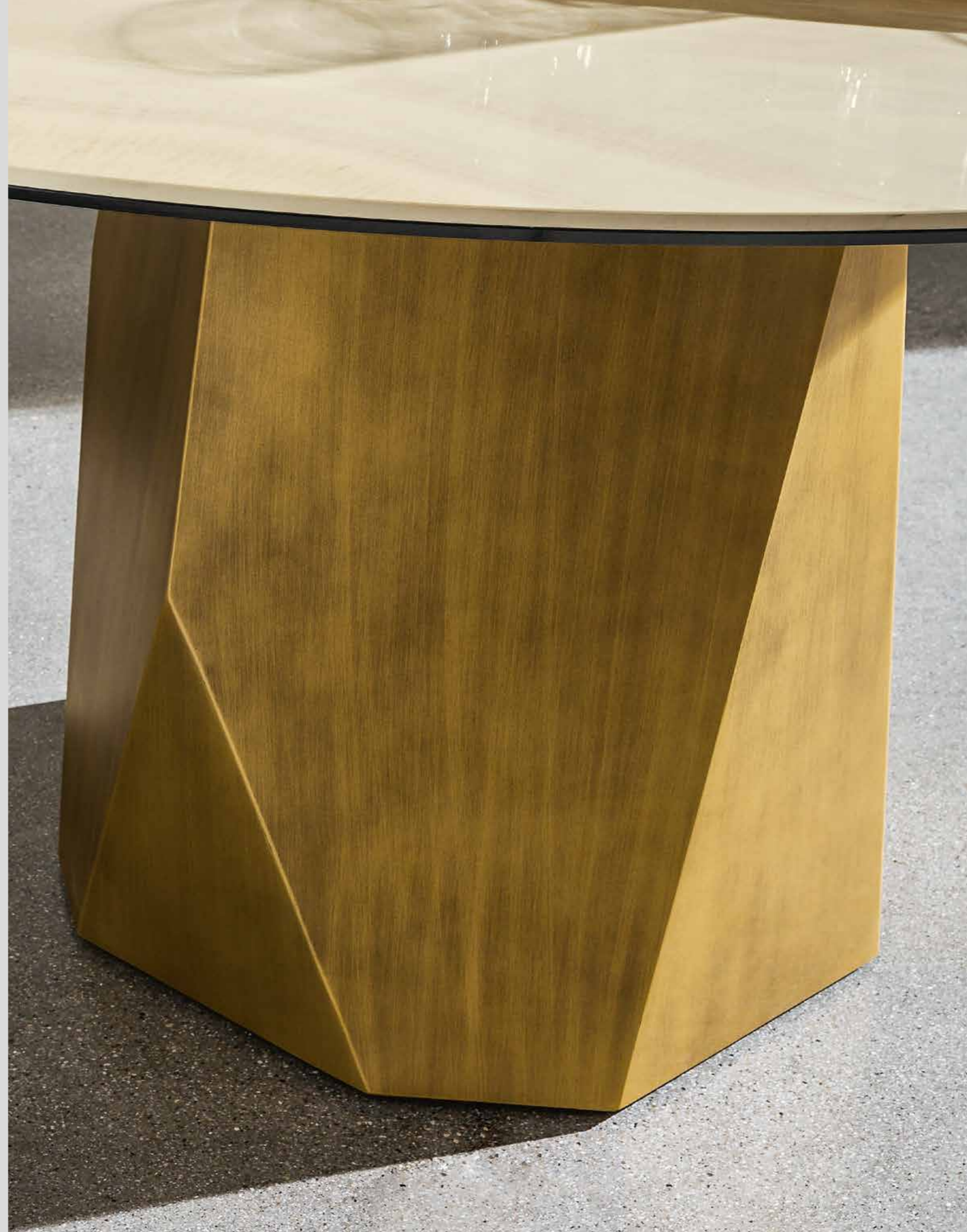

top

Glass Vetro



TETE
Extralight glass
Vetro extrachiaro



TTF
Smoked glass
Vetro fumé

CAT. B



TEB1
Extralight glass lacquered
milky white
Vetro extrachiaro laccato
bianco latte



TEC1
Extralight glass
lacquered mocha
Vetro extrachiaro
laccato caffè



TEC2
Extralight glass
lacquered clay
Vetro extrachiaro
laccato creta



TEC3
Extralight glass
lacquered cement
Vetro extrachiaro
laccato col. cemento



TER4
Extralight glass
lacquered rust
Vetro extrachiaro
laccato col. ruggine



TEV2
Extralight glass
lacquered moss green
Vetro extrachiaro
laccato col. muschio



TEN1
Extralight glass
lacquered black
Vetro extrachiaro
laccato nero

CAT. D



TEM6
Vetro extrachiaro
laccato col. tabacco
Extralight glass
lacquered tobacco



TES1
Vetro extrachiaro
laccato champagne
Extralight glass lacquered
champagne

Frosted glass Vetro acidato

CAT. E



AEAE
Vetro acidato
Frosted glass



AEB1
Extralight glass
lacquered mocha
Vetro extrachiaro
laccato caffè



AEC2
Frosted clay glass
Vetro acidato creta



AEC3
Frosted
cement glass
Vetro acidato
col. cemento



AES1
Frosted champagne
glass
Vetro acidato
champagne

Net glass



NEB1
White Net glass
Net glass bianco



NEC1
Mocha Net glass
Net glass caffè



NEC2
Clay Net glass
Net glass creta

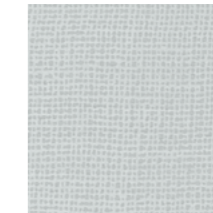

NEC3
Cement Net glass
Net glass col. cemento

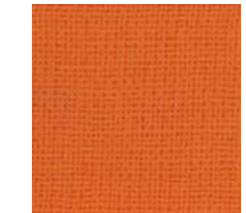

NER4
Rust Net glass
Net glass col. ruggine



NEV2
Moss green Net glass
Net glass col. muschio

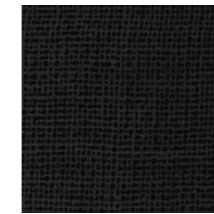

NEN1
Black Net glass
Net glass nero



NEM6
Tobacco
Net glass
Net glass col.
tabacco



NES1
Champagne
Net glass
Net glass
champagne

Liquid glass

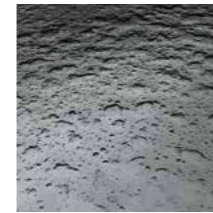

LFLF
Smoked Liquid glass

Materia



MESP
Pearly
materia glass
Vetro materia
perlato



MBSP
Bronzed
materia glass
Vetro materia
bronzo

Wood
Legni



NC
Canaletto walnut
Noce Canaletto



RN
Natural oak wood
Rovere naturale



RG
Grey lacquered oak
Rovere tinto grigio



WG
Wengé-stained oak
Rovere tinto wengè

Ceramic
Ceramica
Categoria CE1

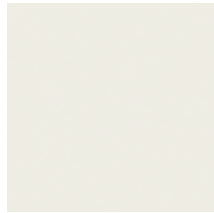

CT
Ceramic titanio
Ceramica titanio



CJ
Ivory black ceramic
Ceramica Ivory Black



CD
Dark ceramic
Ceramica dark

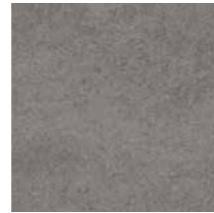

CG
Grey ceramic
Ceramica grey



CZ
Ceppo di Grè ceramic
Ceramica Ceppo di Grè

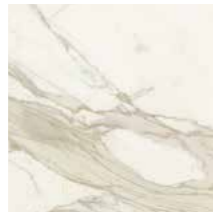

CC
Pre-polished Calacatta ceramic
Ceramica Calacatta Prelucidata

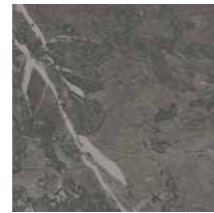

CX
Pre-polished Stone Grey ceramic
Ceramica Stone Grey Prelucidata



KC
Corten ceramic
Ceramica Corten

Ceramic
Ceramica
Categoria CE1



CA
Arabescato light ceramic
Ceramica Arabescato light



CL
Polished Calacatta ceramic
Ceramica Calacatta lucida



CY
Stone grey ceramic
Ceramica Stone grey



CU
Gaudi Stone ceramic
Ceramica Gaudi Stone



CV
Ombra di Caravaggio ceramic
Ceramica Ombra di Caravaggio

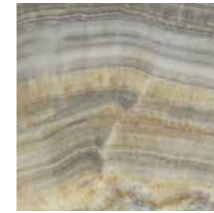

CH
Grey onyx ceramic
Ceramica Onice grigio



CI
Gold Onyx ceramic
Ceramica Onice oro

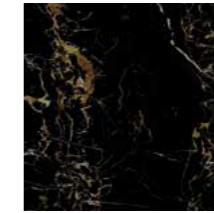

CO
Portoro ceramic
Ceramica Portoro



CQ
Polished Marquinia ceramic
Ceramica Marquinia lucida



CF
Eramosa ceramic
Ceramica Eramosa



CW
Antique ceramic
Ceramica Antique

base

Metal

Metallo



GN

Embossed black
Nero goffrato



GB

Embossed white
Caffè goffrato



GC

Embossed Mocha
Caffè goffrato



GT

Embossed clay
Caffè goffrato



BR

Burnished metal
Metallo brunito

Materiali e manutenzione

ITA

Vetro

Le laccature utilizzate non presentano problemi di durata: basta evitare graffi e urti contro oggetti particolarmente duri e spigolosi. Il vetro è colorato solo sulla faccia posteriore sia nei vetri laccati coprenti mono e bicolore che nei vetri acidati laccati. La tonalità dei campioni proposti è indicativa e non va pertanto intesa in senso restrittivo; può infatti differire leggermente in conformità ai margini di tolleranza riconosciuti per i materiali impiegati. I materiali impiegati possono essere puliti tranquillamente solo con acqua oppure con un detergente neutro. Evitare l'uso di abrasivi, acidi o reagenti chimici. Il vetro è interpretato attraverso la sua trasparenza, pertanto la conformità al campione può differire a seconda della superficie e degli spessori impiegati. Un esempio lampante è dato dal vetro extrachiaro che nei campioncini si presenta completamente neutro ma che nei piani di dimensioni maggiori e con spessori più consistenti assume sfumature azzurro/verdi. Per tale ragione vi preghiamo anche di segnalare con particolare attenzione articoli che debbano essere affiancati o facenti parte di una stessa commissione.

La finitura bicolore consiste nella doppia laccatura nella parte interna della lastra di vetro. La prima laccatura, visibile attraverso la trasparenza del vetro, è disponibile nelle categorie B-D. La seconda laccatura, visibile internamente, equivale al colore pastello opaco utilizzato per ottenere le finiture di cat. B. Vi facciamo presente che in questo caso l'effetto finale differisce da quello creato dalla medesima laccatura attraverso il vetro, in particolare nei colori tenui.

Specchi

Gli specchi oro e rosa potrebbero presentare delle piccole imperfezioni dovute alle caratteristiche tecniche del materiale. Non possono essere utilizzati in luoghi umidi. Pulire solo con panni asciutti.

Ceramica

I campioni riportati sono una parte delle lastre che vengono lavorate. La lastra completa si può vedere nella corrispondente cartella. Pulire utilizzando acqua e una piccola quantità di detergente neutro. Evitare l'utilizzo di detersivi contenenti cere e prodotti ceranti per evitare la formazione di strati untuosi.

Legno

I colori dei legni sono campioni indicativi. Pulire utilizzando un panno morbido inumidito.

Metalli

I colori dei metalli sono campioni indicativi. Pulire utilizzando un panno morbido inumidito.

Tessuti/Pelli/Ecopelli/Velluti

I colori dei tessuti sono campioni indicativi. Per la cura e la manutenzione fare riferimento alle indicazioni riportate nelle rispettive cartelle e alle schede tecniche fornite dai produttori.

Se permangono dubbi contattare l'azienda.

Colours and maintenance

ENG

Glass

The lacquering used for our furniture is extremely durable as long as you avoid scratching it or bumping particularly hard/sharp objects against it. The glass is lacquered only on the back side both for mono or two-tones lacquered and frosted lacquered glasses. The shade of the samples is only indicative and has not to be taken as restrictive. It can in fact slightly differ in conformity to the tolerances recognized for the materials used. All the materials we use can be easily cleaned with water only or with a mild detergent. Do not use abrasive materials, acids or harsh chemicals. The glass is interpreted through its transparency, therefore the conformity to the sample might differ according to the surface and the thickness used. For example, the extralight glass is completely neutral when seen in the small samples, but it takes a light blue/greenish shade when used on bigger or thicker tops. For this reason, we beg you to indicate carefully those articles which have to be placed side by side or which are part of the same commission.

The two-tones finish consists of a double lacquering on the internal part of the glass sheet. The first lacquering, which is visible through the transparency of the glass, is available in the finishes of cat. B-D. The second lacquering, which is visible internally, is the same of the mat pastel used to get the finishes of cat. B. Please notice that the final effect is different from the one created by the same lacquering through the glass, in particular when it comes to soft colours.

Mirrors

Gold and rose mirrors could have small imperfections due to the particular technical characteristics of the material. We recommend not to use them in damp areas. Clean only with a dry cloth.

Ceramic

The shown samples are part of the bigger slabs Sovet works with. The complete slab is visible in the corresponding folder. Clean using water and a small amount of neutral detergent. Avoid using detergents with wax and waxing products to avoid the formation of greasy layers.

Wood

Wood colours are indicative samples. Clean using a damp soft cloth.

Metals

Metals colours are indicative samples. Clean using a damp soft cloth.

Fabrics/Leathers/Fake leathers/velvets

Fabrics colours are indicative samples. For care and maintenance please refer to the instructions present in the corresponding folders and to the technical sheets provided by the manufacturers.

In case of further doubt please get in touch with the factory.

Bordi/Edges

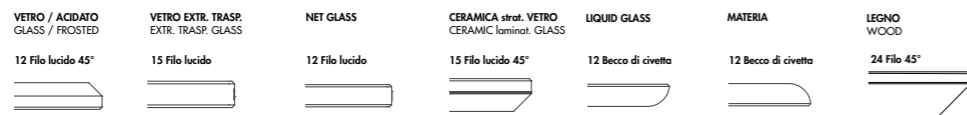

	VETRO / ACIDATO GLASS / FROSTED	VETRO EXTR. TRASP. EXTR. TRASP. GLASS	NET GLASS	CERAMICA strat. VETRO CERAMIC laminat. GLASS	LIQUID GLASS	MATERIA	LEGNO WOOD
● Ø 100x75h	•		•	•	•	•	
● Ø 120x75h	•		•	•	•	•	•
● Ø 130x75h	•		•	•	•	•	
● Ø 140x75h	•		•	•	•	•	
● Ø 150x75h	•		•	•	•	•	•
● Ø 170x75h	•		•				
● 220x115x75h	•		•	•	•	•	
● 250x120x75h	•		•	•	•	•	
● 300x135x75h	•	•	•	•		•	

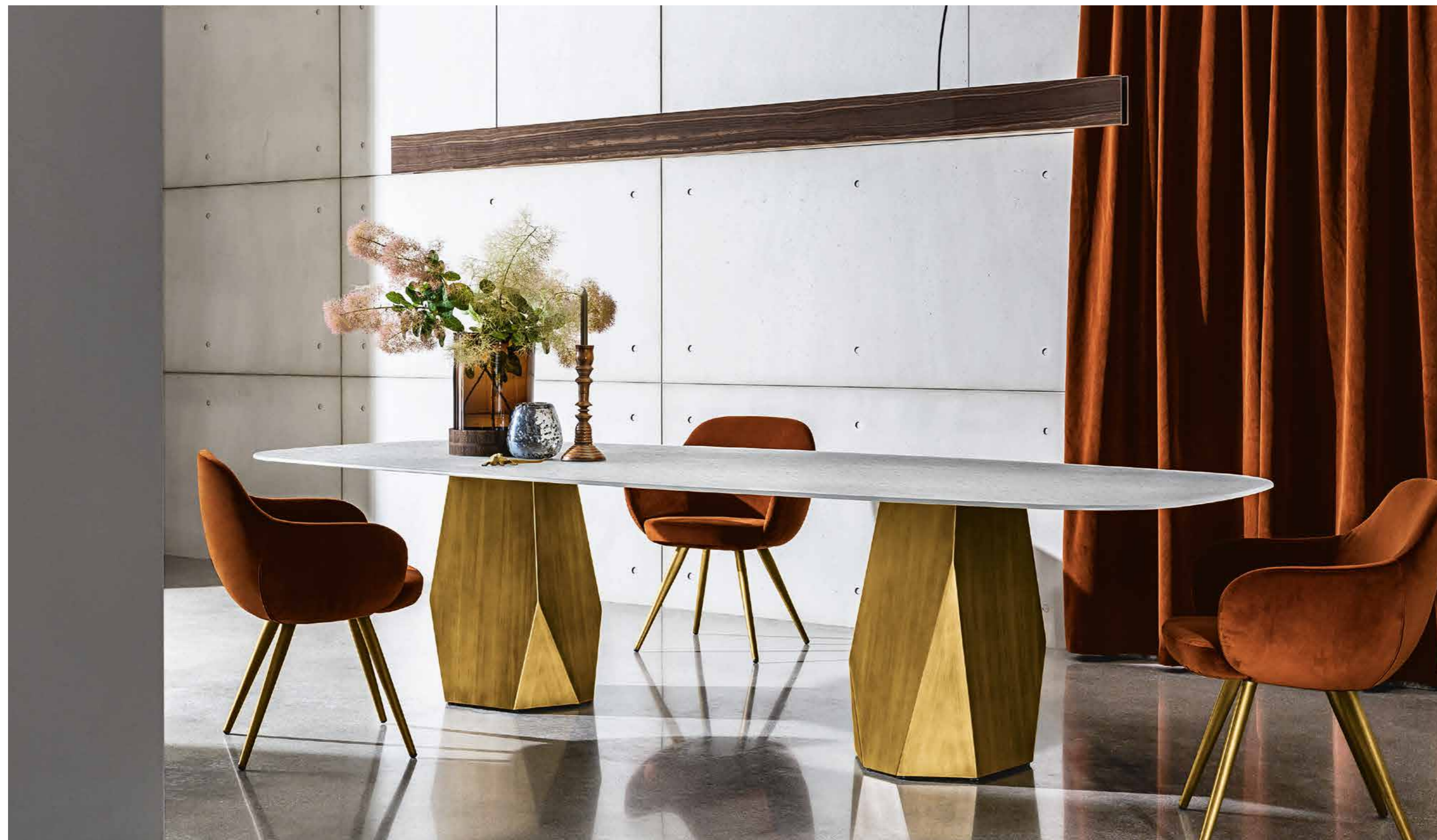

Deed two bases bases BR top MESP.
Cadira cone shapes chairs base BR seat velvet Z09.



Deod two bases structure GC top LFLF.
 Cadira S cone shaped structure GN seat E04.
 Traled structure CQ.



Deod base GN top LFLF.
 Autumn base DF seat P53.
 Visual structure BR mirror SESP.



Deod base BR top TETE.
Cadira base GN seat Hallingdal 103.



Deod base GN top TEC3.
Autumn base DF seat leather P53.



designer

Gianluigi Landoni

Gianluigi Landoni, graduated in architecture at Politecnico di Milano, in 1985 he participated to the founding of the design trend group Amalgama. From 1988 to 1990 project manager at Rodolfo Bonetto's studio. From 1991 partner of studio Progetica Design where he carries out research and development of industrial design, deepening the themes of product design. He has carried out his own professional activity as a consultant to "design oriented" companies in various productive sectors, and he founded with Rosaria Sofia Galli ALTROdesign multidisciplinary studio. At the same time he works on set-ups and realizations for furnishing companies in the hotel and commercial sector. He has also participated in exhibitions and competitions, receiving prizes and awards, not least the report to the 1991 edition of the Compasso d'Oro and subsequent Premio Compasso d'Oro in the 1998 edition. First prize Competition ADI/Expo 2015.

Gianluigi Landoni si è laureato in architettura al Politecnico di Milano. Nel 1985 ha fondato il gruppo di tendenza di design "Amalgama". Ha lavorato per lo studio Rodolfo Bonetto dal 1988 al 1990, e dal 1997 è partner dello studio Progetica Design, dove svolge un progetto di ricerca e sviluppo del design industriale e di prodotto. Ha anche fondato lo studio multidisciplinare ALTROdesign con Rosaria Sofia Galli.

Dal 2001 svolge l'attività professionale in proprio come consulente ad aziende "design oriented" in vari settori produttivi, e si occupa parallelamente di allestimenti e realizzazioni per aziende di arredamento nel settore alberghiero e commerciale. Ha inoltre partecipato a numerose mostre e concorsi, ricevendo premi e riconoscimenti, non ultima la segnalazione all'edizione 1991 del Compasso d'oro e successivo Premio Compasso d'oro nell'edizione del 1998. È membro dell'Osservatorio permanente del design, dell'ADI Design Index e del Consiglio direttivo ADI Lombardia.



sustainability is made up of facts.

Sovet has always maintained a high attention to eco-compatibility since its birth in its birth in 1987, through the selection of raw materials and the study of production processes that have the least impact on the environment with the aim of creating long-lasting products.

Sovet ha sempre mantentenuo alta l'attenzione all'ecocompatibilità sin dalla sua nascita nel 1987, attraverso la selezione delle materie prime e lo studio di processi produttivi che abbiano il minimo impatto sull'ambiente con lo scopo di creare prodotti durevoli nel tempo.

photovoltaic systems



For its production processes Sovet uses energy coming directly from renewable sources. Thanks to its photovoltaic systems it is able to meet its own energy demand.

Per la sua produzione Sovet utilizza infatti energia derivante direttamente da fonti rinnovabili. Attraverso impianti fotovoltaici riesce a soddisfare il proprio fabbisogno energetico.



502695,549 kg emmission saved per year



2989 tree saved per year



165 barrel of oil saved per year

packaging



Sovet uses cardboard packaging with limited presence of oil-derivate.

Sovet usa imballi di cartone costruiti ad hoc con limitata presenza di derivati del petroli.



reduce plastic is an habits



To reduce the consumption of plastic and disposable bottles within its offices and production, Sovet created metal water bottles.

Per ridurre il consumo di plastica e bottiglie monouso all'interno dei suoi uffici e della produzione, Sovet ha creato delle borracce in metallo.

made in italy

The creative use of industrial processes, the use of raw materials of absolute quality and the scrupulous work of master craftsmen, allow Sovet to create high quality and 100% Made in Italy collections. Thanks to state-of-the-art industrial automation systems, Sovet is able to meet also large supply needs for contract spaces, always granting the highest quality standards. The company takes a continuous search path for materials, to create an offer of accessories complementing one another, furnishing different kinds of environments with the maximum customization possibility.

L'impiego creativo dei processi industriali, l'utilizzo di materie prime di assoluta qualità e le scrupolose lavorazioni eseguite da maestranze artigiane, permettono a Sovet di ottenere collezioni di alta qualità e 100% Made in Italy. Grazie a sistemi di automazione industriale all'avanguardia Sovet è in grado di soddisfare anche esigenze per grandi forniture destinate a spazi contract, sempre garantendo i più elevati standard qualitativi. Sovet intraprende un percorso di ricerca dei materiali per creare un'offerta di complementi che si integrino tra di loro, arredando varie tipologie di ambienti con la massima possibilità di personalizzazione.

